



OWNER'S MANUAL

MICROWAVE OVEN

Please read this owner's manual thoroughly before operating.

MS259**** / MS429****
(optional, please check model specification)



MFL69621102_05

www.lg.com

Copyright © 2016 - 2017 LG Electronics Inc. All Rights Reserved

How the Microwave Function Works

Microwaves are a form of energy similar to radio, television waves, and ordinary daylight. Normally, microwaves spread outwards as they travel through the atmosphere and disappear without effect.

This oven, however, has a magnetron that is designed to make use of the energy in microwaves. Electricity, supplied to the magnetron tube, is used to create microwave energy.

These microwaves enter the cooking area through openings inside the oven. A tray is located inside the oven. Microwaves cannot pass through metal walls of the oven, but they can penetrate such materials as glass, porcelain and paper, the materials out of which microwave-safe cooking dishes are constructed.

Microwaves do not heat cookware, though cooking vessels will eventually get hot from the heat generated by the food.

A very safe appliance

Your Microwave oven, is one of the safest of all home appliances. When the door is opened, the oven automatically stops producing microwaves. Microwave energy is converted completely to heat when it enters food, leaving no "left over" energy to harm you when you eat your food.

CONTENTS

3 IMPORTANT SAFETY INSTRUCTIONS

8 BEFORE USE

- 8 Unpacking & Installing
- 10 Control Panel
- 10 Display Icon Meanings
- 11 Slide Touch Key
- 11 The right Touch
- 11 The wrong Touch
- 12 Setting Clock
- 12 Quick Start
- 12 More/Less
- 12 Energy Saving

13 HOW TO USE

- 13 Manual Cooking
- 13 Microwave Power Levels
- 14 Child Lock
- 14 Reheat
- 14 Reheat Menu Instructions
- 15 Popular Menu / Sensor Cook
- 16 Popular Menu / Sensor Cook Instructions
- 18 Soften
- 18 Soften Menu Instructions
- 19 Melt
- 19 Melt Menu Instructions
- 20 Proof (Fermenting)
- 20 Proof Menu Instructions
- 21 Keep Warm
- 22 Inverter Defrost
- 22 Inverter Defrost Menu Instructions

23 MICROWAVE-SAFE UTENSILS

24 FOOD CHARACTERISTICS & MICROWAVE COOKING

26 TO CLEAN YOUR OVEN

26 USING THE SMART DIAGNOSIS™ FUNCTION

27 QUESTION & ANSWERS

28 TECHNICAL SPECIFICATIONS

IMPORTANT SAFETY INSTRUCTIONS

READ CAREFULLY AND KEEP FOR FUTURE REFERENCE

Read and follow all instructions before using your oven to prevent the risk of fire, electric shock, personal injury, or damage when using the oven. This guide does not cover all possible conditions that may occur.

Always contact your service agent or manufacturer about problems that you do not understand.

WARNING

This is the safety alert symbol. This symbol alerts you to potential hazards that can cause death or serious injury. All safety messages will follow the safety alert symbol and either the word "WARNING" or "CAUTION". These words mean:

WARNING

This symbol will alert you to hazards or unsafe practices which could cause serious bodily harm or death.

CAUTION

This symbol will alert you to hazards or unsafe practices which could cause bodily injury or property damage.

WARNING

- 1 **Do not attempt to tamper with, or make any adjustments or repairs to the door, door seals, control panel, safety interlock switches or any other part of the oven which would involve the removal of any cover protecting against exposure to microwave energy. Do not operate the oven if the door seals and adjacent parts of the microwave oven are faulty. Repairs should only be undertaken by a qualified service technician.**
 - Unlike other appliances, the microwave oven is a high-voltage and a high electrical-current piece of equipment. Improper use or repair could result in harmful exposure to excessive microwave energy or in electric shock.
- 2 **Do not use the oven for the purpose of dehumidification. (ex. Operating the microwave oven with wet newspapers, clothes, toys, electric devices, plants, soil, pets or any other living matter inside it.) The oven must only be used for heating or cooking food.**
 - It can be the cause of serious damage or safety risk such as fire, causing burns or sudden death due to an electric shock.
- 3 **This appliance is not intended for use by persons (including children) with reduced physical, sensory or mental capabilities, or lack of experience and knowledge, unless they have been given supervision or instruction concerning use of the appliance by a person responsible for their safety. (Young) Children should be supervised to ensure that they do not play with the appliance.**
 - Improper use may cause damage such as a fire, electric shock or burn.
- 4 **Accessible parts may become hot during use. Young children should be kept away.**
 - They may be burnt.
- 5 **Liquids and other foods must not be heated in sealed containers since they are liable to explode. Remove the plastic wrapping from food before cooking or defrosting. Note though that in some cases food should be covered with plastic film, for heating or cooking. Never heat baby bottles with the lid or teat still fitted.**
 - Doing so can cause an explosion.
- 6 **Be certain to use proper accessories for each operation mode.**
 - Improper use could result in damage to your oven and accessories, or could cause sparks and fire.
- 7 **Children must not be allowed to play with accessories or hang down from the door or any part of the oven.**
 - Doing so can cause serious injury and damage.

- 8 **I**t is hazardous for anyone other than a competent person to carry out any service or repair operation that involves the removal of a cover which gives protection against exposure to microwave energy.
- 9 **W**hen the appliance is operated in the combination mode (for ovens with Combination function), children should only use the oven under adult supervision due to the temperatures generated.
- 10 **D**o not operate your oven if it is damaged. **I**t is particularly important that the oven door closes properly and that there is no damage to the: (1) door(bent), (2) hinges and latches (broken or loose), (3) door seals and sealing surfaces.
 - It could result in harmful exposure to excessive microwave energy.
- 11 **I**f the door or door seals are damaged, the oven must not be operated until it has been repaired by a competent person.
- 12 **T**he appliance is supplied from a cord extension set or an electrical portable outlet device, the cord extension set on electrical portable outlet device must be positioned so that it is not subject to splashing or ingress of moisture.
- 13 **O**nly allow children to use the oven without supervision when adequate instructions have been given so that the child is able to use the oven in a safe way and understands the hazards of improper use.
- 14 **T**he appliance and its accessible parts become hot during use. **C**are should be taken to avoid touching heating elements. **C**hildren less than 8 years of age shall be kept away unless continuously supervised.
- 15 **D**uring use the appliance becomes hot. **C**are should be taken to avoid touching heating elements inside the oven.
- 16 **D**o not use harsh abrasive cleaners or sharp metal scrapers to clean the oven door glass since they can scratch the surface, which may result in shattering of the glass

CAUTION

- 1 **Y**ou cannot operate your oven with the door open due to the safety interlocks built into the door mechanism. **I**t is important not to tamper with the safety interlocks.
 - It could result in harmful exposure to excessive microwave energy. (Safety interlocks automatically switch off any cooking activity when the door is opened.)
- 2 **D**o not place any object (such as kitchen towels, napkins, etc.) between the oven front face and the door or allow food or cleaner residue to accumulate on sealing surfaces.
 - It could result in harmful exposure to excessive microwave energy.
- 3 **P**lease ensure cooking times are correctly set, small amounts of food require shorter cooking or heating times.
 - Over cooking may result in the food catching on fire and subsequent damage to your oven.
- 4 **W**hen heating liquids, e.g. soups, sauces and beverages in your microwave oven,
 - * **A**void using straight sided containers with narrow necks.
 - * **D**o not overheat.
 - * **S**tir the liquid before placing the container in the oven and again halfway through the heating time.
 - * **A**fter heating, let it stand in the oven for a short time; stir or shake it again carefully and check the temperature of it before consuming to avoid burns (especially, contents of feeding bottles and baby food jars).
 - **B**e careful when handling the container. **M**icrowave heating of beverages can result in delayed eruptive boiling, therefore care must be taken when handling the container.
- 5 **A**n exhaust outlet **w**ill be located on the top, bottom or side of the oven. **D**on't block the outlet.
 - It could result in damage to your oven and poor cooking results.
- 6 **D**o not operate the oven when empty. **I**t is best to leave a glass of water in the oven when not in use.

- T**he water will safely absorb all microwave energy, if the oven is accidentally started.
- Improper use could result in damage to your oven.
- 7 Do not cook food wrapped in paper towels, unless your cook book contains instructions for the food you are cooking. And do not use newspaper in place of paper towels for cooking.**
- Improper use can cause an explosion or a fire.
- 8 Do not use wooden containers and ceramic containers that have metallic (e.g. gold or silver) inlays. Always remove metal twist ties. Only use utensils that are suitable for use in microwave ovens. Metallic containers for food and beverages must not be used during microwave cooking.**
- They may heat-up and char. Metal objects in particular may arc in the oven, which can cause serious damage.
- 9 Do not use recycled paper products.**
- They may contain impurities which may cause sparks and/or fires when used in cooking.
- 10 Do not rinse trays and racks by placing them in water just after cooking. This may cause breakage or damage.**
- Improper use could result in damage to your oven.
- 11 Be certain to place the oven so the front of the door is 8 cm or more behind the edge of the surface on which it is placed, to avoid accidental tipping of the appliance.**
- Improper use could result in bodily injury and oven damage.
- 12 Before cooking, pierce the skin of potatoes, apples or any such fruit or vegetables.**
- Not doing so could cause them to burst or rupture.
- 13 Do not cook eggs in their shell. Eggs in their shell and whole hard-boiled eggs should not be heated in microwave ovens since they may explode, even after microwave heating has ended.**
- Pressure will build up inside the egg which will burst.
- 14 Do not attempt deep fat frying in your oven.**
- This could result in a sudden boil over of the hot liquid and may even cause a fire.
- 15 If smoke is observed (or emitted), switch off or unplug the appliance and keep the door closed in order to stifle any flame.**
- Not doing so could cause serious damage such as a fire or electric shock.
- 16 When heating food in plastic or paper containers, keep an eye on the oven due to the possibility of ignition .**
- Your food may leak from the container due to the possibility of container deterioration, which also can cause a fire.
- 17 The temperature of accessible surfaces may be high when the appliance is operating. Do not touch the oven door, outer cabinet, rear cabinet, oven cavity, accessories and dishes during grill mode, convection mode (for ovens fitted with these functions) and auto cook operations, before clearing make sure they are not hot.**
- As they will become hot, there is the danger of a burn unless wearing thick culinary gloves.
- 18 The oven should be cleaned regularly and any food deposits should be removed.**
- Failure to maintain the oven in a clean condition could lead to deterioration of the surface that could adversely affect the life of the appliance and possibly result in a hazardous situation.
- 19 Only use the temperature probe recommended for this oven.**
- You can not ascertain that the temperature is accurate with an unsuitable temperature probe.
 - This model doesn't provide a temperature probe.

20 This appliance is intended to be used in household and similar applications such as:

- Staff kitchen areas in shops, offices and other working environments;
- Farm houses;
- By clients in hotels, motels and other residential environments;
- Bed and breakfast type environments.

This product is intended for domestic household applications only and not for commercial use. It must not be used in mobile applications.

21 This appliance can be used by children aged from 8 years and above and persons with reduced physical, sensory or mental capabilities or lack of experience and knowledge if they have been given supervision or instruction concerning use of the appliance in a safe way and understand the hazards involved. Children shall not play with the appliance. Cleaning and user maintenance shall not be made by children unless they are aged from 8 years and above and supervised.

22 The microwave oven is intended for heating food and beverages. Drying of food or clothing and heating of warming pads, slippers, sponges, damp cloth and similar may lead to risk of injury, ignition or fire.

23 The appliance is not intended to be operated by means of an external timer or separate remote-control system.

24 Follow exact directions given by each manufacturer for their popcorn product. Do not leave the oven unattended while the corn is being popped. If corn fails to pop after the suggested times, discontinue cooking. Never use a brown paper bag for popping corn. Never attempt to pop leftover kernels.

- Overcooking could result in the corn catching a fire.

25 This appliance must be earthed.

Only connect the supply lead plug to an earthed power outlet socket that has the same rating and specification requirement of the oven. If you are unsure about your outlet socket earth connection, it should be checked by an electrical contractor. Never cut off the earth pin of the power plug. ⚡

If the supply cord is damaged, it must be replaced by the manufacturer, its service agent or similarly qualified persons in order to avoid a hazard.

- Improper use may cause serious electric damage or electric shock.

26 Only use utensils that are suitable for use in microwave ovens.

27 This oven should not be used for commercial catering purposes.

- Improper use could result in damage to your oven.

28 The microwave oven must not be placed in a cabinet.

- The microwave oven is intended to be used freestanding.

29 The power connection may be achieved by having the plug accessible in the event of any occurrence, or by incorporating a switch in the fixed wiring in accordance with the wiring rules.

- Using improper plug or switch can cause an electric shock or a fire.

30 The door or the outer surface may get hot when the appliance is operating.

31 Keep the appliance and its cord out of reach of children less than 8 years.

32 The contents of feeding bottles and baby food jars shall be stirred or shaken and the temperature checked before consumption, in order to avoid burns.

- 33 **K**ee the inside and outside of the oven clean. **F**or details of how to clean your oven pls refer to the above content " **T**o **C**lean **Y**our **O**ven ".
- 34 **A**lways install the oven according to the installation requirements that are outlined in this manual.
- 35 **D**o not use any steam cleaners to clean the oven.
- 36  **C**autation, hot surface
When the symbol is used, It means that the surfaces are liable to get hot during use.
- 37 **D**o not place an object (a book, a box, ect.) on the product. **T**he product may overheat or catch fire or the object may fall, causing injury to persons.

BEFORE USE

UNPACKING & INSTALLING

By following the basic steps on these two pages you will be able to quickly check that your oven is operating correctly. Please pay particular attention to the guidelines on where to install your oven. When unpacking your oven make sure you remove all accessories and packing materials. Check to make sure that your oven has not been damaged during shipping.

- 1 Unpack your oven and place it on a flat level surface.

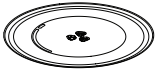

GLASS TRAY



ROTATING RING



TURNTABLE SHAFT

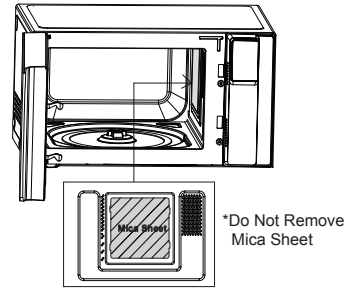

! NOTE

- Do not remove the cavity Mica Sheet (silver plate) inside of oven. The Mica Sheet is there to protect the microwave components from food spatters.

- 2 Place the oven on the level location of your choice with more than 85cm height but make sure there is at least 15 cm of space on the top and 10 cm at the left & right for proper and 5 cm at the rear ventilation. The front of the oven should be at least 8 cm from the edge of the surface to prevent tipping.

An exhaust outlet is located on the bottom and side of the oven. Blocking the outlet can damage the oven.

If you use the microwave oven in an enclosed space or cupboard, The air flow for cooling the product could be worse. It may result in lower performance and reduced service life. If possible, please use the microwave oven in the counter top condition.

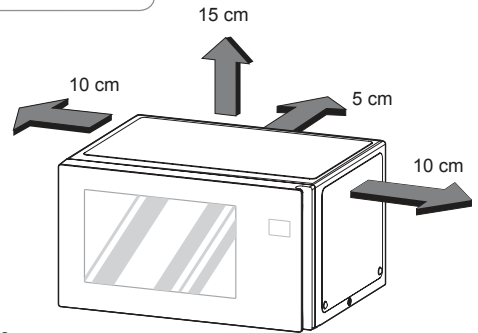

! NOTE

- THIS OVEN SHOULD NOT BE USED FOR COMMERCIAL CATERING PURPOSES. DO NOT USE THIS OVEN IN A BUILT IN APPLICATION.

- 3 Plug your oven into a standard household socket. Make sure your oven is the only appliance connected to the socket. **If your oven does not operate properly, unplug it from the electrical socket and then plug it back in.**

- 4 Open your oven door by pulling the door handle. Place the rotating ring inside the oven and place the glass tray on top.

- 5 Fill a **microwave safe container** with 300 ml (1/2 pint) of water. Place on the glass tray and close the oven door. If you have any doubts about what type of container to use please refer to Microwave-safe utensils.

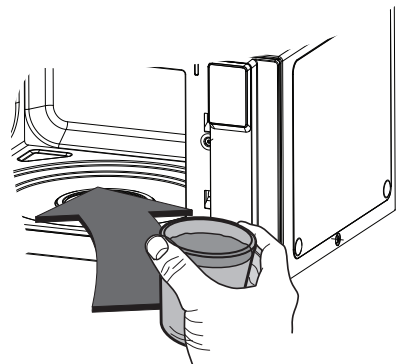

- 6 Press the **STOP** button, and press the **START** button one time to start 30 seconds of cooking time.



- 7 The **DISPLAY** will count down from 30 seconds. When it reaches 0 it will chime briefly. Open the oven door and test the temperature of the water. If your oven is operating the water should be warm. **Be careful when removing the container as it may be hot.**



YOUR OVEN IS NOW INSTALLED

- 8 The contents of feeding bottles and baby food jars must be stirred or shaken and the temperature checked before consumption in order to avoid burns.

- 9 Button recognition may be hampered in the following circumstances:
- Only the outside area of the button is pressed.
 - The button is pushed using a nail or the tip of the finger.

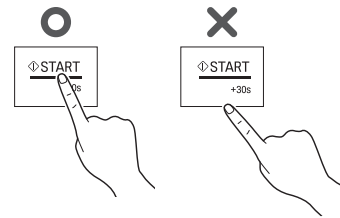

! NOTE

Do not use rubber gloves or disposable gloves.
When wiping the touch control panel with a wet towel, remove moisture from the touch control panel when finished.

- 10 The setting of the cooking time should be shorter than common microwave ovens (700 W, 800 W) due to the relatively high output power of the product. Excessive heating with the product may cause moisture on the door.

CONTROL PANEL

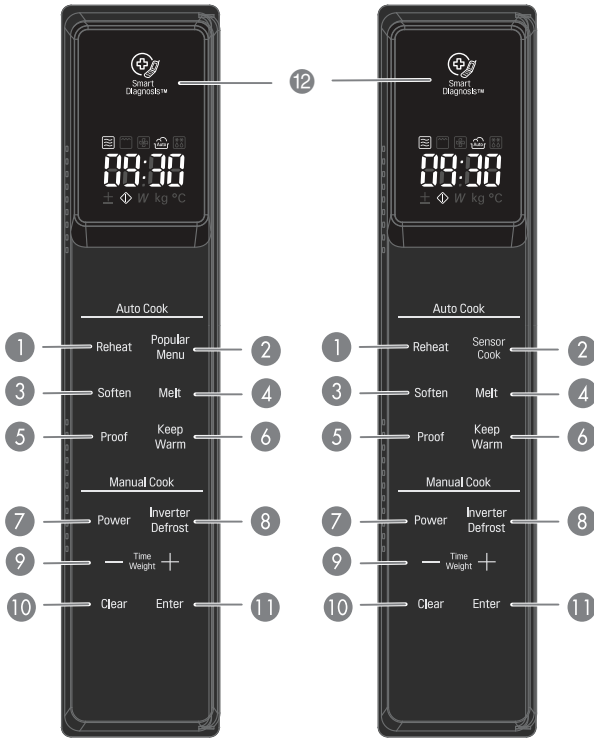

MS259 ****

MS429 ****

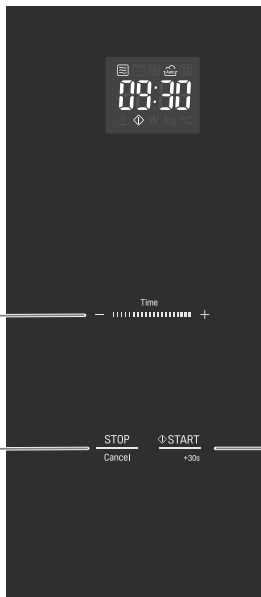
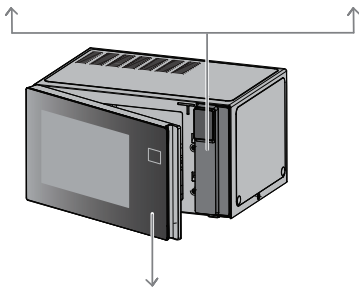

Part	
1	REHEAT See page 14 "Reheat"
2	POPULAR MENU / SENSOR COOK See page 15 "Popular Menu" / "Sensor Cook"
3	SOFTEN See page 18 "Soften"
4	MELT See page 19 "Melt"
5	PROOF See page 20 "Proof"
6	KEEP WARM See page 21 "Keep warm"
7	POWER See page 13 "Timed Cooking"
8	INVERTER DEFROST See page 22 "Inverter Defrost"
9	MORE / LESS See page 12 "More / Less" <ul style="list-style-type: none"> • Choose the cooking menu. • Set cooking time and weight. • While cooking with auto and manual function, you can increase or decrease the cooking time at any point by pressing the - or + keys, or sliding the slide touch key. See page 11 "Slide Touch Key" (except defrost mode).
10	STOP / CLEAR • Clears all functions and set entries except time of day.
11	START / ENTER <ul style="list-style-type: none"> • Press this button to start cooking or resume cooking if the door was opened or the STOP button was pressed once. • The quick start feature allows you to set 30 second intervals of HIGH power cooking with each touch of the quick start button.
12	SMART DIAGNOSIS Hold the mouthpiece of a phone up to this icon when directed to by service centre personnel, to help diagnose problems with the microwave oven when calling for service.

DISPLAY ICON MEANINGS

Icon	
	Shows when the Microwave function is in operation.
	Shows when the Auto Cook function is in operation.
	Shows when the Inverter Defrost function is in operation.
	Shows in the display when More/Less time can be set.
	Shows when Cooking can be started by pressing the START button.
P-10~HI	Shows when the Cooking power level should be set.
kg	Shows when the food weight should be set.



SLIDE TOUCH KEY

By using the slide touch, you can adjust the cooking time or Defrost weight.

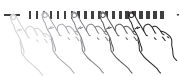
Example: Increase the cooking time, Touch and slowly slide from left to right.

- 
1. Touch the (-) symbol of slide touch key with your finger.
- 
2. To increase the time, slowly slide your finger to the right.

Example: To Reduce cooking time, Touch and slowly slide from right to left.

- 
1. Touch the (+) symbol of slide touch key with your finger.
- 
2. To reduce the time, slowly slide your finger to the left.

NOTE

- Time setting
 - 0~3 minutes : Time setting will increase or decrease by 10 second increments.
 - 3~20 minutes : Time setting will increase or decrease by 30 second increments.
 - 20~90minutes : Time setting will increase or decrease by 1 minute increments.
 - Operating microwave : Remaining time will increase or decrease by 10 second increments.
- Defrost weight is set the same way as the cooking time. It will increase or decrease by 0.1kg.

THE RIGHT TOUCH

- (-), (+) keys at both ends of Slide Touch Key can be used like the normal touch keys. By repeatedly touching the key once like the picture, you can set up the Cooking time or Defrost weight.

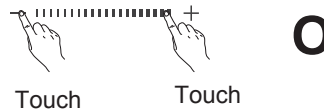

- Place your finger in a centred position and sliding it along the centre of the slide scale.

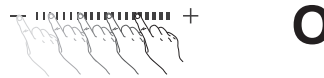

THE WRONG TOUCH

If you touch the key as follows, the slide touch key may not be recognised.

- Touching the outside of the slide touch key.



- Touching the slide touch key using your finger nail or thumb.
- Sliding the slide touch key too fast.

NOTE

- Don't use rubber gloves or disposable gloves when using the touch key or any other device or tool other than a finger.
- When wiping the touch control panel with a wet towel, dry off any remaining moisture from the touch control panel.
- If a (+), (-) button on the touch control panel is being pressed, and the setting no longer increases or decreases, then remove your finger and try again.

SETTING CLOCK

When your oven is plugged in for the first time or when power resumes after a power interruption, the numbers in the display reset to '12H'.

Example: To set 11:11

1. Open the Door.
Press **+** once.
'24H' will show in the display. (press **+** twice for 12 Hour mode)
2. Press **Enter**.
3. Press **+** eleven times until display shows '11.'
4. Press **Enter**.
5. Press **+** eleven times until display shows '11:11'
6. Press **Enter**.

NOTE

- You can also set the time by using the slide Touch Key after closing the door.
- If you want to set the clock again or change options, you will need to unplug the power cord and reconnect.
- If you don't want to use clock mode, Press **STOP/CANCEL** button, after plugging in your oven.

QUICK START

The QUICK START feature allows you to set 30 seconds intervals of HIGH power cooking with each touch of the START button.

Example: Set 2 minutes of cooking on high power

1. Close the Door.
Press **STOP**.
2. Select 2 minutes on high power.

Press the **START** button four times

The oven will start before you have finished the fourth press.

During QUICK START cooking, you can extend the cooking time up to 99 minutes 59 seconds by repeatedly pressing the **START** button.

MORE/LESS

By using the (-) or (+) key, manual cook settings can be adjusted to cook food for a longer or shorter time. Pressing (+) will increase 10 seconds to the cooking time each time you press it. Pressing (-) will decrease 10 seconds of cooking time each time you press it. The max cooking time possible in the manual cook mode will be 99 min 59 seconds.

Example: To adjust the Reheat (ex. Dinner Plate 1 Serve) cooking time for a longer time, or for a shorter time

1. Open the Door.
Press **Clear**.
2. Press **Reheat** three times.
'3' will show in the display.
3. Press **Enter**.
4. Close the Door.
Press **START**.
5. Slide (+) or (-) Remaining time will increase or decrease by 10 seconds.

ENERGY SAVING

Energy saving means to save energy by turning off the display. This feature only operates when the Microwave Oven is in standby and the display will go out.

NOTE

- When using clock mode, the display will remain on.

HOW TO USE

MANUAL COOKING

(timed cooking)

This function allows you to cook food for a desired time. There are 10 power levels available. The example below shows how to set 90% power level for the desired time.

Example: To cook food on 90% Power for 5 minutes 30 seconds

1. Open the Door. Press **Clear**.
2. Press **Power** twice, Display shows 'P-90 '. (1st time P-HI appears in the display. This is to tell you that the oven is set on 100% power unless a different power setting is chosen.)
3. Enter 5 minutes 30 seconds by pressing **+** until display shows '5:30'.
4. Close the Door. Press **START**.

When cooking is complete, a chime will sound. The word **End** shows in the display window. 'End' remains in the display and the chime will sound every minute until the door is opened, or any button is pressed.

NOTE

- If you do not select the power level, the oven will operate at power HIGH. To set HI-POWER cooking, skip step 2 above.

MICROWAVE POWER LEVELS

Your microwave oven is equipped with 10 power levels to give you maximum flexibility and control over cooking. The adjacent table will give you some idea of which foods are prepared at each of the various power levels.

- The adjacent chart shows the power level settings for your oven.

MICROWAVE POWER LEVEL CHART

Power Level		Use
MS259****	MS429****	
P-HI (100 %) 1000 W	P-HI (100 %) 1200 W	* Boiling water. * Browning ground beef. * Making candy. * Cooking poultry pieces, fish, & vegetables. * Cooking tender cuts of meat.
P-90 900 W	P-90 1080 W	* Reheating rice, pasta, & vegetables.
P-80 800 W	P-80 960 W	* Reheating prepared foods quickly. * Reheating sandwiches.
P-70 700 W	P-70 840 W	* Cooking egg, milk and cheese dishes. * Cooking cakes and breads. * Melting chocolate.
P-60 600 W	P-60 720 W	* Cooking veal. * Cooking whole fish. * Cooking puddings and custard. * Reheating Quiche MS429**** : about 7~8 minutes for 600 g. MS259**** : about 8~9 minutes for 600 g.
P-50 500 W	P-50 600 W	* Cooking ham, whole poultry and lamb. * Cooking rib roast and sirloin tip.
P-40 400 W	P-40 480 W	* Thawing meat, poultry and seafood.
P-30 300 W	P-30 360 W	* Cooking less tender cuts of meat. * Cooking pork chops and roast.
P-20 200 W	P-20 240 W	* Taking chill out of fruit. * Softening butter.
P-10 100 W	P-10 120 W	* Keeping casseroles and main dishes warm. * Softening butter and cream cheese.



CHILD LOCK

This is a unique safety feature that prevents unwanted oven operations. Once the CHILD LOCK is set, no cooking can take place.

Example: To set the CHILD LOCK



1. Close the Door. Press **STOP**.





2. Press and hold **STOP** until 'Loc' appears in the display and a chime is heard.

If the time of day was already set, the time of day will appear on the display window after 1 seconds.

If the CHILD LOCK was already set and you touch another key pad, the word Loc shows in the display. You can cancel the CHILD LOCK according to below procedure.

Example: To cancel the CHILD LOCK



Press and hold **STOP** until 'Loc' disappears in the display.

After the CHILD LOCK is turned off, the oven will operate normally.



REHEAT

Your oven's menu has been preprogrammed to automatically reheat food. Select one of the Reheat menus and then select the weight of the food. The microwave will then reheat the contents appropriately after the START button is pressed as in step 4 below.

Example: To reheat 0.2 kg Rice, simply follow the step below



1. Open the Door. Press **Clear**.





2. Press **Reheat** seven times. '7' will show in the display.

MS259****
OR



MS429****

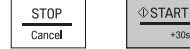

3. Press **+** until display shows '0.2 kg'.

4. Close the Door. Press **START**.

REHEAT MENU INSTRUCTIONS

Code	Menu	Weight Limit	Initial Temperature	Instructions	Utensil
1	Beverage	1 - 2 cups (1 cup / 200 ml)	Room	1. Place food in a microwave-safe cup. 2. Place food in the oven. Choose the menu and weight, press START.	Microwave-safe cup
2	Casserole	0.25 - 1.0 kg (250 g / 1 serving)	Refrigerated	1. Place food in a microwave-safe bowl. Cover with plastic wrap and vent. Or a vented lid. 2. Place food in the oven. Choose the menu and weight, press START. 3. After cooking, stand covered for 3 minutes.	Microwave-safe bowl
3	Dinner Plate	1	Refrigerated	1. Place food (0.4 - 0.5 kg of meat, chicken, mashed potato, vegetable etc.) on a microwave-safe dish. Cover with plastic wrap and vent. Or a vented lid. 2. Place food in the oven. Choose the menu, press START. 3. After cooking, stand covered for 3 minutes.	Microwave-safe dish
4	Muffin	1 - 4 (75 - 80 g / 1 muffin)	Frozen	1. Place food on a microwave-safe dish. 2. Place food in the oven. Choose the menu and weight, press START.	Microwave-safe dish

Code	Menu	Weight Limit	Initial Temperature	Instructions	Utensil
5	Pie	0.2 - 0.6 kg (150 - 200 g / piece)	Refrigerated	1. Cut leftover pie into serving size pieces. 2. Place food on a microwave-safe dish. 3. Place food in the oven. Choose the menu and weight, press START.	Microwave-safe dish
6	Pizza	0.2 - 0.5 kg	Refrigerated	1. Place food on a microwave-safe dish. 2. Place food in the oven. Choose the menu and weight, press START.	Microwave-safe dish
7	Rice	0.1 - 0.3 kg	Refrigerated	1. Place food in a microwave-safe bowl. Cover with plastic wrap and vent. Or vented lid. 2. Place food in the oven. Choose the menu and weight, press START. 3. After cooking, stand covered for 3 minutes.	Microwave-safe bowl
8	Soup	0.25 - 1.0 kg (250 g / 1 serving)	Room	1. Place food in a microwave-safe bowl. Cover with plastic wrap and vent. Or vented lid. 2. Place food in the oven. Choose the menu and weight, press START. 3. After cooking, stand covered for 3 minutes.	Microwave-safe bowl

Note: Plastic wrap should not touch the food when covering

POPULAR MENU / SENSOR COOK

Your oven's menu has been preprogrammed to automatically cook food. Select a Popular Menu and weight, or, select one of the Sensor Cook menus and then press START to allow the microwave to cook your selection. Then let your microwave oven cook your selections.

Example: To cook 0.4 kg Fresh Vegetable, simply follow the step below	
MS259****	MS429****
<div style="display: flex; justify-content: space-between; align-items: center; margin-bottom: 10px;"> <div style="border: 1px solid black; padding: 2px 5px;">Clear</div> <div style="border: 1px solid black; padding: 2px 5px;">Enter</div> <div style="margin-left: 20px;">1. Open the Door. Press Clear.</div> </div> <div style="text-align: center; margin-bottom: 10px;">↓</div> <div style="display: flex; justify-content: space-between; align-items: center; margin-bottom: 10px;"> <div style="border: 1px solid black; padding: 2px 5px;">Reheat</div> <div style="border: 1px solid black; padding: 2px 5px;">Popular Menu</div> <div style="margin-left: 20px;">2. Press Popular Menu three times. '3' will show in the display.</div> </div> <div style="text-align: center; margin-bottom: 10px;">↓</div> <div style="display: flex; justify-content: space-between; align-items: center; margin-bottom: 10px;"> <div style="border: 1px solid black; padding: 2px 5px;">-</div> <div style="border: 1px solid black; padding: 2px 5px;">+</div> <div style="margin-left: 20px;">3. Press + until display shows '0.4 kg'.</div> </div> <div style="text-align: center; margin-bottom: 10px;">↓</div> <div style="display: flex; justify-content: space-between; align-items: center;"> <div style="border: 1px solid black; padding: 2px 5px;">STOP Cancel</div> <div style="border: 1px solid black; padding: 2px 5px;">START +30s</div> <div style="margin-left: 20px;">4. Close the Door. Press START.</div> </div>	<div style="display: flex; justify-content: space-between; align-items: center; margin-bottom: 10px;"> <div style="border: 1px solid black; padding: 2px 5px;">Clear</div> <div style="border: 1px solid black; padding: 2px 5px;">Enter</div> <div style="margin-left: 20px;">1. Open the Door. Press Clear.</div> </div> <div style="text-align: center; margin-bottom: 10px;">↓</div> <div style="display: flex; justify-content: space-between; align-items: center; margin-bottom: 10px;"> <div style="border: 1px solid black; padding: 2px 5px;">Reheat</div> <div style="border: 1px solid black; padding: 2px 5px;">Sensor Cook</div> <div style="margin-left: 20px;">2. Press Sensor Cook three times. '3' will show in the display.</div> </div> <div style="text-align: center; margin-bottom: 10px;">↓</div> <div style="display: flex; justify-content: space-between; align-items: center;"> <div style="border: 1px solid black; padding: 2px 5px;">STOP Cancel</div> <div style="border: 1px solid black; padding: 2px 5px;">START +30s</div> <div style="margin-left: 20px;">3. Close the Door. Press START.</div> </div>

POPULAR MENU / SENSOR COOK INSTRUCTIONS

Code	Menu	Weight Limit	Initial Temperature	Instructions	Utensil																																																																											
1	Bacon	4 thin rashers	Refrigerated	<ol style="list-style-type: none"> Place food on paper towels on a microwave-safe dish. Cover with paper towels. Place food in the oven, choose the menu, press START. 	Microwave-safe dish																																																																											
2	Casserole	1 - 4	Room	<p>Tuna & Noodle</p> <table border="1"> <thead> <tr> <th>Serving</th> <th>1</th> <th>2</th> <th>3</th> <th>4</th> </tr> </thead> <tbody> <tr> <td>Noodles(Pasta), boiled</td> <td>140 g</td> <td>280 g</td> <td>420 g</td> <td>560 g</td> </tr> <tr> <td>Cream of mushroom soup</td> <td>140 g</td> <td>280 g</td> <td>420 g</td> <td>560 g</td> </tr> <tr> <td>Can or equivalent, Starkist chunk light tuna, in spring water, drained</td> <td>60 g</td> <td>120 g</td> <td>180 g</td> <td>240 g</td> </tr> <tr> <td>Milk</td> <td>125 ml</td> <td>250 ml</td> <td>375 ml</td> <td>500 ml</td> </tr> </tbody> </table> <ol style="list-style-type: none"> Combine cream of mushroom soup, tuna and milk in a microwave- safe bowl. Add boiled noodles and stir thoroughly. Cover with plastic wrap and vent. Or vented lid. Place food in the oven. Choose the menu and weight, press START. After cooking, stand covered for 3 minutes. <p>Beef Stroganoff</p> <table border="1"> <thead> <tr> <th>Serving</th> <th>1</th> <th>2</th> <th>3</th> <th>4</th> </tr> </thead> <tbody> <tr> <td>Rump steak, cubed</td> <td>250 g</td> <td>500 g</td> <td>750 g</td> <td>1000 g</td> </tr> <tr> <td>Plain flour</td> <td>2 Tbsp</td> <td>1/4 cup</td> <td>1/2 cup</td> <td>1/2 cup</td> </tr> <tr> <td>Small onion, finely chopped</td> <td>1/2</td> <td>1</td> <td>1</td> <td>1</td> </tr> <tr> <td>Tomato puree</td> <td>2 tsp</td> <td>1 Tbsp</td> <td>1 1/2 Tbsp</td> <td>2 Tbsp</td> </tr> <tr> <td>Beef stock</td> <td>125 ml</td> <td>200 ml</td> <td>250 ml</td> <td>375 ml</td> </tr> <tr> <td>Red wine</td> <td>60 ml</td> <td>60 ml</td> <td>60 ml</td> <td>60 ml</td> </tr> <tr> <td>Mushroom, sliced</td> <td>25 g</td> <td>50 g</td> <td>75 g</td> <td>100 g</td> </tr> <tr> <td>Sour cream</td> <td>75 ml</td> <td>150 ml</td> <td>200 ml</td> <td>300 ml</td> </tr> <tr> <td>Salt and pepper to taste</td> <td></td> <td></td> <td></td> <td></td> </tr> </tbody> </table> <ol style="list-style-type: none"> Place steak, flour and all other ingredients in a microwave-safe bowl. Cover with plastic wrap and vent. Or vented lid. Place food in the oven. Choose the menu and weight, press START. After cooking, stand covered for 3 minutes. 	Serving	1	2	3	4	Noodles(Pasta), boiled	140 g	280 g	420 g	560 g	Cream of mushroom soup	140 g	280 g	420 g	560 g	Can or equivalent, Starkist chunk light tuna, in spring water, drained	60 g	120 g	180 g	240 g	Milk	125 ml	250 ml	375 ml	500 ml	Serving	1	2	3	4	Rump steak, cubed	250 g	500 g	750 g	1000 g	Plain flour	2 Tbsp	1/4 cup	1/2 cup	1/2 cup	Small onion, finely chopped	1/2	1	1	1	Tomato puree	2 tsp	1 Tbsp	1 1/2 Tbsp	2 Tbsp	Beef stock	125 ml	200 ml	250 ml	375 ml	Red wine	60 ml	60 ml	60 ml	60 ml	Mushroom, sliced	25 g	50 g	75 g	100 g	Sour cream	75 ml	150 ml	200 ml	300 ml	Salt and pepper to taste					Microwave-safe bowl
Serving	1	2	3	4																																																																												
Noodles(Pasta), boiled	140 g	280 g	420 g	560 g																																																																												
Cream of mushroom soup	140 g	280 g	420 g	560 g																																																																												
Can or equivalent, Starkist chunk light tuna, in spring water, drained	60 g	120 g	180 g	240 g																																																																												
Milk	125 ml	250 ml	375 ml	500 ml																																																																												
Serving	1	2	3	4																																																																												
Rump steak, cubed	250 g	500 g	750 g	1000 g																																																																												
Plain flour	2 Tbsp	1/4 cup	1/2 cup	1/2 cup																																																																												
Small onion, finely chopped	1/2	1	1	1																																																																												
Tomato puree	2 tsp	1 Tbsp	1 1/2 Tbsp	2 Tbsp																																																																												
Beef stock	125 ml	200 ml	250 ml	375 ml																																																																												
Red wine	60 ml	60 ml	60 ml	60 ml																																																																												
Mushroom, sliced	25 g	50 g	75 g	100 g																																																																												
Sour cream	75 ml	150 ml	200 ml	300 ml																																																																												
Salt and pepper to taste																																																																																
3	Fresh Vegetables	0.2 - 0.8 kg	Room	<ol style="list-style-type: none"> Prepare vegetables(carrots, broccoli, cauliflower, zucchini, beans, peas). Cut vegetables into even size pieces. Wash the vegetables and place food in a microwave- safe bowl. Add amount of water according to the quantity (0.2 - 0.4 kg: 2 tablespoons, 0.5 - 0.8 kg: 4 tablespoons). Cover with plastic wrap and vent. Or vented lid. Place food in the oven. Choose the menu and weight, press START. After cooking, stir and stand covered for 3 minutes. 	Microwave-safe bowl																																																																											
4	Frozen Meat Pie	0.2 - 0.8 kg (150 - 200 g / piece)	Frozen	<ol style="list-style-type: none"> Remove all packaging. Place food on a microwave-safe dish. Place food in the oven. Choose the menu, press START. 	Microwave-safe dish																																																																											

Code	Menu	Weight Limit	Initial Temperature	Instructions	Utensil																																
5	Frozen Vegetables	0.2 - 0.8 kg	Frozen	<ol style="list-style-type: none"> 1. Prepare frozen vegetables(carrots, broccoli, cauliflower, zucchini, beans, peas). 2. Place food in a microwave-safe bowl. 3. Add amount of water according to the quantity (0.2 - 0.4 kg: 2 tablespoons, 0.5 - 0.8 kg: 4 tablespoons). Cover with plastic wrap and vent. Or vented lid. 4. Place food in the oven. Choose the menu and weight, press START. 5. After cooking, stir and stand covered for 3 minutes. 	Microwave-safe bowl																																
6	Jacket Potatoes	0.2 - 1.0 kg (180 - 220 g / each)	Room	<ol style="list-style-type: none"> 1. Wash potatoes and dry with a paper towel. 2. Pierce each potato 8 times with a fork. 3. Place food on a paper towel in the oven. Choose the menu and weight, press START. 4. After cooking, stand for 3 minutes. 	Paper towel																																
7	Rice/Pasta	0.1 - 0.3 kg	Room	<p>Ingredients for rice</p> <table border="1"> <tbody> <tr> <td>Rice</td> <td>100 g</td> <td>200 g</td> <td>300 g</td> </tr> <tr> <td>Butter, melted</td> <td>30 g</td> <td>40 g</td> <td>50 g</td> </tr> <tr> <td>Onion, grated</td> <td>50 g</td> <td>75 g</td> <td>100 g</td> </tr> <tr> <td>Chicken stock or water</td> <td>250 ml</td> <td>500 ml</td> <td>750 ml</td> </tr> <tr> <td>Salt</td> <td colspan="3">To taste</td> </tr> </tbody> </table> <ol style="list-style-type: none"> 1. Add rice, melted butter and onion in a deep and large microwave-safe bowl(3 L) and mix well. Pour boiling chicken stock or water and add salt. Cover with plastic wrap and vent. 2. Place food in the oven. Choose the menu and weight, press START. 3. After cooking, stir and stand covered for 5 - 10 minutes if needed. <p>Ingredients for pasta</p> <table border="1"> <tbody> <tr> <td>Pasta</td> <td>100 g</td> <td>200 g</td> <td>300 g</td> </tr> <tr> <td>Water</td> <td>400 ml</td> <td>800 ml</td> <td>1000 ml</td> </tr> <tr> <td>Salt</td> <td colspan="3">To taste</td> </tr> </tbody> </table> <ol style="list-style-type: none"> 1. Place pasta and boiling water with salt in a deep and large microwave-safe bowl(3 L). Cover with plastic wrap and vent. 2. Place food in the oven. Choose the menu and weight, press START. 3. After cooking, Rinse pasta with cold water. 	Rice	100 g	200 g	300 g	Butter, melted	30 g	40 g	50 g	Onion, grated	50 g	75 g	100 g	Chicken stock or water	250 ml	500 ml	750 ml	Salt	To taste			Pasta	100 g	200 g	300 g	Water	400 ml	800 ml	1000 ml	Salt	To taste			Microwave-safe bowl
Rice	100 g	200 g	300 g																																		
Butter, melted	30 g	40 g	50 g																																		
Onion, grated	50 g	75 g	100 g																																		
Chicken stock or water	250 ml	500 ml	750 ml																																		
Salt	To taste																																				
Pasta	100 g	200 g	300 g																																		
Water	400 ml	800 ml	1000 ml																																		
Salt	To taste																																				
8	Risotto	1.2 kg	Room	<table border="1"> <tbody> <tr> <td>Ingredients</td> </tr> <tr> <td>200 g risotto rice</td> </tr> <tr> <td>1 1/2 cups water or stock</td> </tr> <tr> <td>1/2 cup milk</td> </tr> <tr> <td>200 g raw beef, chopped</td> </tr> <tr> <td>2 eggs</td> </tr> <tr> <td>1 onion, chopped</td> </tr> <tr> <td>50 g frozen green peas</td> </tr> <tr> <td>100 g grated cheese</td> </tr> <tr> <td>Salt and pepper to taste</td> </tr> </tbody> </table> <ol style="list-style-type: none"> 1. Add all ingredients in a deep and large microwave-safe bowl and mix well. Cover with plastic wrap and vent. 2. Place the bowl in the oven. Choose the menu, press START. 3. After cooking, stir and stand covered for 5 - 10 minutes if needed. 	Ingredients	200 g risotto rice	1 1/2 cups water or stock	1/2 cup milk	200 g raw beef, chopped	2 eggs	1 onion, chopped	50 g frozen green peas	100 g grated cheese	Salt and pepper to taste	Microwave-safe bowl																						
Ingredients																																					
200 g risotto rice																																					
1 1/2 cups water or stock																																					
1/2 cup milk																																					
200 g raw beef, chopped																																					
2 eggs																																					
1 onion, chopped																																					
50 g frozen green peas																																					
100 g grated cheese																																					
Salt and pepper to taste																																					

SOFTEN

The oven uses low power to soften foods (butter, cream cheese and ice cream) See the following table.

Example: To Soften 0.2 kg Cream Cheese.

1. Open the Door.
Press **Clear**.

2. Press **Soften** twice.
'2' will show in the display.

3. Press **+** until display shows '0.2 kg'.









4. Close the Door.
Press **START**.

SOFTEN MENU INSTRUCTIONS

Code	Menu	Weight Limit	Initial Temperature	Instructions	Utensil
1	Butter	1 - 3 (100 - 150 g / each)	Refrigerated	<ol style="list-style-type: none"> 1. Unwrap and place on a microwave-safe dish. 2. Place food in the oven. Choose the menu and weight, press START. 3. Butter will be at room temperature and ready for use in a recipe. 	Microwave-safe dish
2	Cream Cheese	0.1 ~ 0.3 kg	Refrigerated	<ol style="list-style-type: none"> 1. Unwrap and place on a microwave-safe dish. 2. Place food in the oven. Choose the menu and weight, press START. 3. Cream cheese will be at room temperature and ready for use in a recipe. 	Microwave-safe dish
3	Ice Cream	2 or 4 cups	Frozen	<ol style="list-style-type: none"> 1. Remove lid and cover. 2. Place food in the oven. Choose the menu and weight, press START. 3. Ice cream will be soft enough to make scooping easier. 	

MELT

The oven uses low power to melt foods (butter, cheese and chocolate). See the following table.









Example: To Melt 0.2 kg Chocolate		
		1. Open the Door. Press Clear .
		2. Press Melt three times. '3' will show in the display.
		3. Press + until display shows '0.2 kg'.
		4. Close the Door. Press START .

MELT MENU INSTRUCTIONS

Code	Menu	Weight Limit	Initial Temperature	Instructions	Utensil
1	Butter	1 - 3 (100 - 150 g / each)	Refrigerated	<ol style="list-style-type: none"> 1. Place in a microwave-safe bowl. 2. Place food in the oven. Choose the menu and weight, press START. 3. After cooking, stir to complete melting. 	Microwave-safe bowl
2	Cheese	0.2 ~ 0.4 kg	Refrigerated	<ol style="list-style-type: none"> 1. Use processed cheese food only. Unwrap and cut into cubes. 2. Place in a microwave-safe bowl. 3. Place food in the oven. Choose the menu and weight, press START. 4. After cooking, stir to complete melting. 	Microwave-safe bowl
3	Chocolate	0.1 ~ 0.3 kg	Room	<ol style="list-style-type: none"> 1. Chocolate chips or squares of baking chocolate may be used. 2. Unwrap and place in a microwave-safe bowl. 3. Place food in the oven. Choose the menu and weight, press START. 4. After cooking, stir to complete melting. 	Microwave-safe bowl

PROOF (fermenting)

This feature allows you to make Yogurt by pressing the Proof button.

To make 0.6 kg yogurt	
 	1. Open the Door. Press Clear .
	
 	2. Press Proof once. '1' will show in the display.
	
 	3. Close the Door. Press START . '5h00' will show in the display.

PROOF MENU INSTRUCTIONS

Code	Menu	Weight Limit	Initial Temperature	Instructions	Utensil												
1	Yogurt	0.6 kg	Lukewarm	<p>Ingredients 500 ml pasteurized whole milk 100 g natural plain yogurt</p> <ol style="list-style-type: none"> 1. Thoroughly wash the proper sized microwave-safe bowl with hot water. 2. Pour 500 ml milk into the bowl. 3. Heat it about 1 minutes 30 seconds - 2 minutes 30 seconds on high microwave power until 40 - 50 °C temperature. 4. Add 100 ml yogurt into the bowl and stir well. 5. Cover with plastic wrap or lid and place food in the oven. Choose the menu, press START. 6. After proofing, stand in the refrigerator for about 5 hours. 7. Stir in jam, sugar or fruits to taste. <p>Note :</p> <ul style="list-style-type: none"> The following types of milk and yogurt may be used : <table border="1"> <thead> <tr> <th colspan="2">Do use</th> <th colspan="2">Do not use</th> </tr> <tr> <th>Milk</th> <th>Yogurt</th> <th>Milk</th> <th>Yogurt</th> </tr> </thead> <tbody> <tr> <td>• Pasteurized whole milk</td> <td>• Natural plain yogurt</td> <td>• 2 %, 1 % or fat-free milk • High calcium milk • Soy milk • Leftover milk • Expired milk</td> <td>• Leftover yogurt • Expired yogurt</td> </tr> </tbody> </table> <ul style="list-style-type: none"> • Thoroughly wash all utensils with hot water and dry before proofing yogurt. • Make sure that the milk is lukewarm(40 - 50 °C) before proofing. • Don't shake or mix yogurt during proofing as this will affect the firmness of the yogurt. • If the amount of ingredients are greater than suggested, increase the proofing time. 	Do use		Do not use		Milk	Yogurt	Milk	Yogurt	• Pasteurized whole milk	• Natural plain yogurt	• 2 %, 1 % or fat-free milk • High calcium milk • Soy milk • Leftover milk • Expired milk	• Leftover yogurt • Expired yogurt	Microwave-safe bowl
Do use		Do not use															
Milk	Yogurt	Milk	Yogurt														
• Pasteurized whole milk	• Natural plain yogurt	• 2 %, 1 % or fat-free milk • High calcium milk • Soy milk • Leftover milk • Expired milk	• Leftover yogurt • Expired yogurt														

KEEP WARM

The Keep Warm function will keep hot food that has just been cooked at serving temperature. Use microwave-safe utensils.

Example: To keep food warm for 90minutes

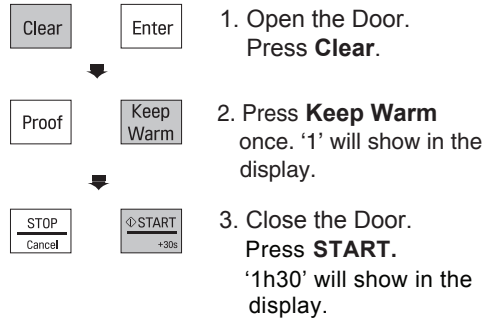

Notes :

Crisp foods (pastry, pies, turnovers, etc) should be uncovered during keep warm.

Moist foods should be covered with plastic wrap or microwave-safe lid.

The amount of keep warm food is suitable for 1-3 servings. It should also be noted that moist food will become dryer the longer it is Kept Warm.









Plastic wrap should not touch the food during heating.

INVERTER DEFROST

Four defrost sequences are preset in the oven. The INVERTER DEFROST feature provides you with the best defrosting method for frozen foods. The cooking guide will show you which defrost sequence is recommended for the food you are defrosting.

For added convenience, the INVERTER DEFROST includes a built-in beep alert that reminds you to check, turn over, separate, or rearrange to get the best defrost results. Four different defrosting levels are provided.

(MEAT / POULTRY / FISH / BREAD)

Example: To defrost 1.2 kg of meat	
 	1. Open the Door. Press Clear and place 1.2kg of frozen meat inside the oven.
 	2. Press Inverter Defrost once. 'dEF1' will show in the display.
 	3. Press + until display shows '1.2 kg'.
 	4. Close the Door. Press START .

NOTE:

When you press the **START** button, the display changes to the defrost time count down. The oven will beep once during the DEFROST cycle.

At the beep, open the door and remove any portions that have thawed and turn.

Return frozen portions to the oven and press **START** to resume the defrost cycle.

- Remove fish, shellfish, meat, and poultry from its original wrapping paper or plastic package. Otherwise, the wrap will hold steam and juice close to the foods, which can cause the outer surface of the foods to cook.
- Place foods in a shallow container or in a microwave roasting dish to catch the drippings.
- Food should still be somewhat icy in the center when removed from the oven.

- The length of defrosting time varies according to how solidly the food is frozen.
- The shape of the package affects how quickly food will defrost. Shallow packages will defrost more quickly than a deep block.
- Depending on the shape of the food can be defrosted more or less.

INVERTER DEFROST MENU INSTRUCTIONS

Category	Food to be Defrosted
MEAT (dEF1) 0.1-4.0 kg	Beef Ground beef, Round steak, Cubes for stew, Tenderloin steak, Pot roast, Rib roast, Rump roast, Chuck roast, Hamburger patty Remove any defrosted portion of ground beef at the beeps. Lamb Chops, Rolled roast Pork Chops, Hot dogs, Spareribs, Country-style ribs. Rolled roast, Sausage Veal Cutlets (0.5 kg, 20 mm thick) Turn food over at beep. After defrosting, let stand for 5 - 15 minutes.
POULTRY (dEF2) 0.1-4.0 kg	Poultry Whole, Cut-up, Breast (boneless). Rinse chicken cavity with tap water and let stand for 60 minutes for better performance. Cornish Hens Whole Turkey Breast Turn food over at beep. After defrosting, rinse with cold water after 30 minutes, let stand for 60 minutes.
FISH (dEF3) 0.1-4.0 kg	Fish Fillets, Whole Steaks Shellfish Crab meat, Lobster tails, Shrimp, Scallops Turn food over at beep. Separate portions if needed. After defrosting, let stand for 5 - 10 minutes.
BREAD (dEF4) 0.1-0.5 kg	Sliced bread, Buns, Baguette, etc. Separate slices and place between paper towel or flat plate. Turn food over at beep. After defrosting, let stand for 1 - 2 minutes.

MICROWAVE-SAFE UTENSILS

Never use metal or metal trimmed utensils in using microwave function

Microwaves cannot penetrate metal. They will bounce off any metal object in the oven and cause arcing, an alarming phenomenon that resembles lightning. Most heat resistant non metallic cooking utensils are safe for use in your oven. However, some may contain materials that render them unsuitable as microwave cookware. If you have any doubts about a particular utensil, there's a simple way to find out if it can be used in the microwave.

Place the utensil in question next to a glass bowl filled with water in using microwave function. Microwave at power HIGH for 1 minute. If the water heats up but the utensil remains cool to the touch, the utensil is microwave-safe. However, if the water does not change temperature but the utensil becomes warm, microwaves are being absorbed by the utensil and it is not safe for use in using microwave function. You probably have many items on hand in your kitchen right now that can be used as cooking equipment in the microwave. Just read through the following checklist.

Dinner plates

Many kinds of dinnerware are microwave-safe. If in doubt consult the manufacturer's literature or perform the microwave test. Do not heat dinner plates that use any painted on decorative as they will arc if the paint has metallic content.

Glassware

Glassware that is heat-resistant is microwave-safe. This would include all brands of oven tempered glass cookware. However, do not use delicate glassware, such as tumblers or wine glasses, as these might shatter as the food warms.

Plastic storage containers

These can be used to hold foods that are to be quickly reheated. However, they should not be used to hold foods that will need considerable time in the oven as hot foods will eventually warp or melt plastic containers.

Paper

Paper plates and containers are convenient and safe to use in using microwave function, provided that the cooking time is short and foods to be cooked are low in fat and moisture. Paper towels are also very useful for wrapping foods and for lining baking trays in which greasy foods such as bacon are cooked. In general, avoid coloured paper products as the colour may run. Some recycled paper products may contain impurities which could cause arcing or fires when used in the microwave.

Plastic cooking bags

Provided they are made specially for cooking, cooking bags are microwave safe. However, be sure to make a slit in the bag so that steam can escape. Never use ordinary plastic bags for cooking in using microwave function, as they will melt and rupture.

Plastic microwave cookware

A variety of shapes and sizes of microwave cookware are available. For the most part, you can probably use items you already have on hand rather than investing in new kitchen equipment.

Pottery, stoneware and ceramic

Containers made of these materials are usually fine for use in using microwave function, but they should be tested to be sure.



CAUTION

- Some items with high lead or iron content are not suitable as cooking utensils.
- Utensils should be checked to ensure that they are suitable for use in the microwave.

FOOD CHARACTERISTICS & MICROWAVE COOKING

Keeping an eye on things

Always watch your food while it cooks. Your microwave function is equipped with a light that turns on automatically when the oven is in operation so that you can see inside and check the progress of your food. Directions given in recipes to elevate, stir, and the like should be thought of as the minimum steps recommended. If the food seems to be cooking unevenly, simply make the necessary adjustments you think appropriate to correct the problem.

Factors affecting microwave cooking times

Many factors affect cooking times. The temperature of ingredients used in a recipe makes a big difference in cooking times. For example, a cake made with ice-cold butter, milk, and eggs will take considerably longer to bake than one made with ingredients that are at room temperature. Some of the recipes, particularly those for bread, cake, and custards, recommend that food be removed from the oven when they are slightly undercooked.

This is not a mistake. When allowed to stand, usually covered, these foods will continue to cook outside of the oven as the heat trapped within the outer portions of the food gradually travels inward. If the food is left in the oven until it is cooked all the way through, the outer portions will become overcooked or even burnt. You will become increasingly skillful in estimating both cooking and standing times for various foods.

Density of food

Light, porous food such as cakes and breads cook more quickly than heavy, dense foods such as roasts and casseroles. You must take care when microwaving porous food so that the outer edges do not become dry and brittle.

Height of food

The upper portion of tall foods, particularly roasts, will cook more quickly than the lower portion. Therefore, it is wise to turn tall food several during cooking.

Moisture content of food

Since the heat generated from microwaves causes moisture to evaporate, relatively dry food such as roasts and some vegetables should either be sprinkled with water prior to cooking or covered to retain moisture.

Bone and fat content of food

Bones conduct heat and fat cooks more quickly than meat. Care must be taken when cooking bony or fatty cuts of meat in order to prevent unevenly or overcooked meat.

Quantity of food

The number of microwaves in your oven remains constant regardless of how much food is being cooked. Therefore, the more food you place in the oven, the longer the cooking time. Remember to decrease cooking times by at least one third when halving a recipe.

Shape of food

Microwaves penetrate only about 2 cm into food, the interior portion of thick foods are cooked as the heat generated on the outside travels inward. Only the outer edge of food is cooked by microwave energy; the rest is cooked by conduction. The worst possible shape for a food that is to be microwaved is a thick square.

The corners will burn long before the centre is even warm. Round thin foods and ring shaped foods cook most successfully in the microwave.

Covering

A cover traps heat and steam which causes food to cook more quickly. Use a lid or microwave cling film with a corner folded back to prevent splitting.

FOOD CHARACTERISTICS & MICROWAVE COOKING

Browning

Meats and poultry that are cooked fifteen minutes or longer will brown lightly in their own fat. Foods that are cooked for a shorter period of time may be brushed with a browning sauce such as worcestershire sauce, soy sauce or barbecue sauce to achieve an appetizing colour. Since relatively small amounts of browning sauces are added to food, the original flavour of the recipe is not altered.

Covering with greaseproof paper

It is a looser cover than a lid or cling film, the food may dry out slightly. But because it makes a looser cover than a lid or clingfilm, it allows the food to dry out slightly.

Arranging and spacing

Individual foods such as baked potatoes, small cakes and hors d'oeuvres will heat more evenly if placed in the oven an equal distance apart, preferably in a circular pattern. Never stack foods on top of one another.

Stirring

Stirring is one of the most important of all microwaving techniques. In conventional cooking, food is stirred for the purpose of blending. Microwaved food, however, is stirred in order to spread and redistribute heat. Always stir from the outside towards the centre as the outside of the food heats first.

Turning over

Large, tall foods such as roasts and whole chickens should be turned so that the top and bottom will cook evenly. It is also a good idea to turn cut up chicken and chops.

Placing thicker portions facing outwards

Since microwaves are attracted to the outside portion of food, it makes sense to place thicker portions of meat, poultry and fish to the outer edge of the baking dish. This way, thicker portions will receive the most microwave energy and the food will cook evenly.

Shielding

Strips of aluminium foil (which block microwaves) can be placed over the corners or edges of square and rectangular foods to prevent those portions from overcooking. Never use too much foil and make sure the foil is secured to the dish or it may cause 'arcing' in the oven especially if the foil passes too closely to the walls of the oven during rotation.

Elevating

Thick or dense foods can be elevated so that microwaves can be absorbed by the underside and centre of the foods.

Piercing

Foods enclosed in a shell, skin or membrane are likely to burst in the oven unless they are pierced prior to cooking. Such foods include yolks and whites of eggs, clams and oysters and whole vegetables and fruits.

Testing if cooked

Food cooks so quickly in a oven, it is necessary to test it frequently. Some foods are left in the microwave until completely cooked, but most foods, including meats and poultry, are removed from the oven while still slightly undercooked and allowed to finish cooking during standing time. The internal temperature of foods will rise between 5 ° F (3 ° C) and 15 ° F (8 ° C) during standing time.

Standing time

Foods are often allowed to stand for 3 to 10 minutes after being removed from the oven. Usually the foods are covered during standing time to retain heat unless they are supposed to be dry in texture (some cakes and biscuits, for example). Standing allows foods to finish cooking and also helps flavour blend and develop.

TO CLEAN YOUR OVEN

1 Keep the inside of the oven clean

Food spatters or spilled liquids stick to oven walls and between the seal and door surfaces. It is best to wipe up spillovers with a damp cloth right away. Crumbs and spillovers will absorb microwave energy and lengthen cooking times and may even damage the oven. Use a damp cloth to wipe out crumbs that fall between the door and the frame. It is important to keep this area clean to assure a tight seal. Remove greasy spatters with a soapy cloth then rinse and dry. Do not use harsh detergent or abrasive cleaners. The metal tray can be washed by hand or in the dishwasher.

2 Keep the outside of the oven clean

Disconnect the mains plug from the power outlet before cleaning the oven to eliminate the possibility of electric shock. Clean the outside of your oven with soap and water then with clean water and dry with a soft cloth or paper towel. To prevent damage to the operating parts inside the oven, the water should not be allowed to seep into the ventilation openings. To clean control panel, open the door to prevent the oven from accidentally starting, and wipe a damp cloth followed immediately by a dry cloth. Press STOP after cleaning.

3 If steam accumulates inside or around the outside of the oven door, wipe the panels with a soft cloth. Steam or condensation build up inside the door is normal if foods are heated for a long period on higher power levels. This is not a malfunction. The condensation will eventually evaporate. Try covering the food or vary the heating levels and time to reduce any condensation forming in the door, this may also occur when the oven is operated under high humidity conditions and in no way indicates a malfunction of the unit.

4 The door and door seals should be kept clean. Use only warm, soapy water, rinse then dry thoroughly. DO NOT USE ABRASIVE MATERIALS, SUCH AS CLEANING POWDERS OR STEEL AND PLASTIC PADS. Metal parts will be easier to maintain if wiped frequently with a damp cloth.

USING THE SMART DIAGNOSIS™ FUNCTION

Use this function if you need an accurate diagnosis by an LG Electronics service centre when the product malfunctions or fails. Use this function only to contact the service representative, not during normal operation.

1. When instructed to do so by the call centre, hold the mouthpiece of your phone over the Smart Diagnosis™ logo on the controller.

NOTE

- Do not touch any other buttons.



2. With the door opened, press and continue to hold the Clear button for 3 seconds so that 'Loc' appears on the display. Continue to hold the Clear button for a further 5 seconds until '5' appears in the display. (so, the Clear button will need to be held for 8 seconds continuously).

A tone will then emit from behind the Smart Diagnosis symbol.

3. Keep the phone in place until the tone transmission has finished. The display will count down the time.

4. Once the countdown is over and the tones have stopped, resume your conversation with the call center agent, who will then be able to assist you in using the information transmitted for analysis.

NOTE

- For best results, do not move the phone while the tones are being transmitted.
- If the call center agent is not able to get an accurate recording of the data, you may be asked to try again.

QUESTIONS & ANSWERS

FAQ	Answer
What's wrong when the oven light will not glow?	There may be several reasons why the oven light will not glow. Either the light bulb has blown or the electric circuit has failed.
Does microwave energy pass through the viewing screen in the door?	No. The holes, or ports, are made to allow light to pass; they do not let microwave energy through.
Why does the BEEP tone sound when a button on the control panel is touched?	The BEEP tone sounds to assure that the setting is being properly entered.
Will the microwave function be damaged if it operates empty?	Yes. Never run it empty.
Why do eggs sometimes pop?	When baking, frying, or poaching eggs, the yolk may pop due to steam build up inside the yolk membrane. To prevent this, simply pierce the yolk before cooking. Never microwave eggs in the shell.
Why is standing time recommended after microwave cooking is over?	After microwave cooking is finished, food keeps on cooking during standing time. This standing time finishes cooking evenly throughout the food. The amount of standing time depends on the density of the food.
Why doesn't my oven always cook as fast as the cooking guide says?	Check your cooking guide again to make sure you've followed directions correctly, and to see what might cause variations in cooking time. Cooking guide times and heat settings are suggestions, chosen to help prevent overcooking, the most common problem in getting used to this oven. Variations in the size, shape, weight and dimensions of the food require longer cooking time. Use your own judgment along with the cooking guide suggestions to test food conditions, just as you would do with a conventional cooker.
'Cool' appears on the display and the cooling fan continues to run after the cooking or heating time is over.	After cooking is complete, the fan may operate to cool the oven. The display will show 'Cool'. If you open the door or press once STOP before the cooking time is complete, the remaining cooking time will show on the display. This is not a malfunction.

When operating the microwave oven, If you use a product such as radio, TV, wireless LAN, Bluetooth, medical equipment, wireless equipment etc. Using the same frequency as the microwave oven, the product may receive interference from these products. This interference does not indicate a problem of the microwave or the product and is not a malfunction. Therefore, it is safe to use. However, medical equipment may receive interference as well, so use caution when using medical equipment near the product.

TECHNICAL SPECIFICATIONS

MS259 * * * *		
Power Input		230-240 V~ 50 Hz
Microwave Output Power.		Max. 1000 W* (IEC60705 rating standard)
Microwave Frequency		2450 MHz
Oven Cavity Dimension	MS259* * * *	322 mm(W) X 228 mm(H) X 335 mm(D)
Outside Dimension		476 mm(W) X 272 mm(H) X 361 mm(D)
Net Weight		8.9 kg
Shipping Weight		11.3 kg
Power Consumption	Microwave	1150 W

*** When operating at 100%, 90%, and 80% power levels for prolonged periods, the output power will be reduced gradually to help prevent the unit from electrically overheating.**

MS429* * * *		
Power Input		230-240 V~ 50 Hz
Microwave Output Power.		Max. 1200 W* (IEC60705 rating standard)
Microwave Frequency		2450 MHz
Oven Cavity Dimension	MS429* * * *	395 mm(W) X 262 mm(H) X 406 mm(D)
Outside Dimension		544 mm(W) X 308 mm(H) X 432 mm(D)
Net Weight		11.3 kg
Shipping Weight		14.8 kg
Power Consumption	Microwave	1350 W

*** When operating at 100%, 90%, and 80% power levels for prolonged periods, the output power will be reduced gradually to help prevent the unit from electrically overheating.**

Microwave Frequency : 2450 MHz +/- 50 MHz (Group 2 / Class B) **

Group 2 equipment: group 2 contains all ISM RF equipment in which radio-frequency energy in the frequency range 9 kHz to 400GHz is intentionally generated and used or only used, in the form of electromagnetic radiation, inductive and /or capacitive coupling, for the treatment of material or inspection/analysis purposes.

Class B equipment is equipment suitable for use in domestic dwellings and domestic dwellings directly connected to a low voltage power supply network which supplies buildings used for domestic purposes.

You can download an owner's manual at <http://www.lg.com>



FOR CUSTOMER SERVICE PLEASE CONTACT LG Service on
1300 LG CARE (1300 54 2273) AUSTRALIA or
0800 LG CARE (0800 54 2273) NEW ZEALAND

www.lg.com

LG Electronics Australia 2 Wonderland Drive Eastern Creek NSW 2766 (ABN : 98 064 531 264)

Printed in China