

INSTRUCTIONS FOR USE
BUILT-IN OVEN
EN

OTP66SSH / OTP66BSH
OTP66GSH
OT66SSH / OT66BSH
OT66GSH
OTP66SSH.AU / OTP66GSH.AU
OTP66BSH.AU

Contents

Introduction	3	Wi-Fi management	30
Safety precautions	4	Using Wi-Fi	30
Safe and correct use of the oven during pyrolytic cleaning	5	Managing the oven remote control	30
Other important safety warnings	6	General tips and advice for baking	32
ConnectLife	8	Cooking table	33
Appliance description	9	Cooking with a food probe	39
Appliance equipment	9	Cleaning and maintenance	42
Control panel	11	Automatic oven cleaning – pyrolysis	43
Before first use	13	Using the Aqua Clean function to clean the oven	45
Switching on for the first time	13	Removing wire and fixed pull-out (extendible) guides	45
Using the oven	15	Removing and replacing the oven door and glass panes	46
Home menu	15	Replacing the bulb	47
Manual cooking mode	16	Troubleshooting	48
Duration of operation - Time function	18	Troubleshooting table	48
Plus menu - additional settings	18	Label – appliance information	49
Auto programs	22	Compliance information	50
Extra functions	23	Environment protection	51
Starting the cooking process	25	Cooking test	52
End of cooking by touching	26		
General settings	27		

We thank you for your trust and the purchase of our appliance.

This detailed instruction manual is supplied to make the use of this product easier. The instructions should allow you to learn about your new appliance as quickly as possible.

Make sure you have received an undamaged appliance. If you do find transport damage, please contact the seller from which you purchased the appliance, or the regional warehouse from which it was supplied. The telephone number can be found on the invoice or on the delivery note.

Carefully read the instructions for use before connecting the appliance. Repair or any warranty claim resulting from incorrect connection or use of the appliance shall not be covered by the warranty.



For more detailed instructions and tips scan the QR code on the rating plate.

The following symbols are used throughout the manual and they have the following meanings:

INFORMATION!

Information, advice, tip, or recommendation

WARNING!

Warning – general danger

ConnectLife

Connect your oven to a Wi-Fi network and the ConnectLife app to access all its functions, including advanced features and remote control.

IMPORTANT SAFETY PRECAUTIONS – CAREFULLY READ THE INSTRUCTIONS AND SAVE THEM FOR FUTURE REFERENCE.

The appliance may only be connected to the power mains by an authorized service technician or expert. Tampering with the appliance or nonprofessional repair thereof may result in risk of severe injury or damage to the product.

Appliance must be connected to fixed wiring which has incorporated means of disconnection. Fixed wiring must be made in accordance with the wiring rules.

For the UK market, fixed wiring is required if the device has more than 3 kW. Only the service department should connect the appliance.

For stationary appliances permanently connected to the fixed wiring, compliance with this requirement is deemed to be met if the disconnection instruction incorporated into the fixed wiring complies with AS/NZS 3000 (Australia only).

The appliance must not be installed behind a decorative door in order to avoid overheating.

WARNING: A damaged power cord or connector must only be replaced by the manufacturer, an authorized service technician, or a qualified professional. Improper handling may result in electric shock, fire, or serious injury.

This appliance can be used by children aged 8 years and above, and by persons with reduced physical, sensory or mental capabilities or lack of experience and knowledge, if they have been given supervision or instruction concerning the use of the appliance in a safe way, and if they understand the hazards involved. Children shall not play with the appliance. Cleaning and user maintenance shall not be done by children without supervision.

WARNING: The appliance and its accessible parts become hot during use; avoid contact with heating elements. Children under 8 years of age must be kept away unless continuously supervised.

The appliance is not intended to be controlled by external timers or separate remote control system.

Only use the food probe recommended for use in this oven.

Do not use harsh abrasive cleaners or sharp metal scrapers to clean the oven door glass/ the glass of hinged lids of the hob (as appropriate), since they can scratch the surface, which may result in shattering of the glass.

Do not use steam cleaners or high-pressure cleaners to clean the appliance as this may result in an electric shock.

Never pour water directly on the bottom of the oven cavity. Temperature differences could result in damage to the enamel coating.

Safe and correct use of the oven during pyrolytic cleaning

Before activating the automatic cleaning process, remove all equipment from the oven: wire rack, spit-roasting kit, all baking trays, food probe, wire guides, and any other cookware that is not a part of the oven equipment.

Before you start the cleaning process, remove any residue of spilt liquid and all moving parts from the oven cavity.

During the automatic cleaning process, the oven heats up to a very high temperature and it is very hot on the outside as well. Risk of burns! Keep children away from the oven.

Other important safety warnings

The appliance is intended for household use. Do not use it for any other purpose, such as room heating, drying of pets or other animals, paper, fabrics, herbs etc. As this may lead to injury or fire hazard.

The appliance may only be connected to the power mains by an authorized service technician or expert. Tampering with the appliance or nonprofessional repair thereof may result in risk of severe injury or damage to the product.

We recommend that (due to appliance weight) at least two persons carry and install the appliance.

Do not lift the appliance by holding it by the door handle.

Oven door hinges may be damaged when under excessive load. Do not stand or sit on the open oven door, and do not lean against it. Also, do not place any heavy objects onto the oven door.

If the power cords of other appliances located in the vicinity of the oven become entangled in the oven door, they may get damaged, which may cause a short circuit. Therefore, make sure that the power cords of other appliances are at a safe distance.

Make sure the vents are never covered or obstructed in any other way.

Do not line the oven walls with aluminium foil and do not place baking trays or other containers on the bottom of the oven. This would reduce air circulation in the oven, obstruct and slow down the baking process and destroy the enamel coating.

We recommend you avoid opening the oven door during baking, as this increases power consumption and condensate accumulation.

At the end of the baking process, and during baking, be careful when opening the oven door, as there is danger of scalding.

To prevent limescale accumulation, leave the oven door open after baking or using the oven, to allow the oven cavity to cool down to room temperature.

Clean the oven when it has completely cooled down.

Eventual mismatches in colour shades between different appliances or components within a single design line may occur due to various factors, such as different angles under which the appliances are observed, different coloured backgrounds, materials, and room illumination.

Do not use the appliance if it is damaged. Unplug the appliance from the power mains and call an authorized service centre.

The oven can be safely used with or without baking pan guides.

Do not store items in the oven, which could cause danger when the oven is switched on.

Before you activate automatic cleaning, carefully read and observe all instructions in the chapter Cleaning and Maintenance, which describes correct and safe use of this function

Do not place anything on the oven bottom during the automatic cleaning process.

Risk of fire! During automatic cleaning, the appliance is heated to very high temperatures, which will incinerate food residues in the appliance. Therefore, remove visible dirt from the inside of the oven and from the utensils before each use. Smoke, irritating fumes and gases may also come from the oven while the cleaning function is active. Therefore, make sure that the room is well-ventilated while you carry out this procedure. Small animals or pets can be very sensitive to any fumes that might come out from the oven. It is recommended to remove them from the room during operation and to ventilate the room well after cleaning.

Other important safety warnings

Do not open the oven door during cleaning.

Make sure no foreign objects enter the opening for locking the door guide, as this could block automatic door locking during the oven cleaning process.

Do not touch any metal surfaces or parts of the appliance during the automatic cleaning process!

In case of a power outage during the automatic cleaning process, the program will be terminated after two minutes and the oven door will remain locked. The door will be unlocked, when the appliance senses that the temperature has dropped to below 150 °C in the centre of the oven cavity.

After the self-cleaning process, the oven cavity and the oven accessories can discolour and lose their sheen. This does not affect their functionality.

WARNING!

Using the oven with the door open and the door switch closed is not permitted.

WARNING!

Carefully read the instructions for use before connecting the appliance. Repair or any warranty claim resulting from incorrect connection or use of the appliance shall not be covered by the warranty.

Connecting the appliance to the ConnectLife application

ConnectLife is a smart home platform that connects people, devices and services. The **ConnectLife** application includes advanced digital services and carefree solutions that allow users to monitor and control appliances, receive notifications from a smartphone, and update software (supported features may vary depending on your appliance and the region/country in which you are located).

To connect your smart device, you need a home Wi-Fi network (only 2.4 GHz networks are supported) and a smartphone equipped with the application **ConnectLife**.

 **ConnectLife**



To download the **ConnectLife** application, scan the QR code or search for **ConnectLife** in your favourite app store.

1. Install the **ConnectLife** application and create an account.
2. In the **ConnectLife** application, go to the "Add device" menu and select the appropriate type of device. Then scan the QR code (it can be found on the nameplate of the appliance; you can also enter the AUID/MV number manually).
3. The application then guides you through the entire process of connecting the appliance to your smartphone.
4. After a successful connection, the appliance can be operated remotely via the mobile application.

INFORMATION!

If this setting is not available, then your oven is not fitted with a Wi-Fi module and does not support internet connectivity.

When the Wi-Fi module is enabled and connections are successfully set up and synchronized, then the oven can be controlled and operated via a mobile device and the **ConnectLife** app.

The Wi-Fi connection works in the same frequency range as some other devices, such as microwave ovens and remote-controlled toys. This may cause intermittent or even permanent disruption of the connection. In such cases, the availability of the offered functions cannot be guaranteed until the connection is restored.

Ensuring the quality of the functions offered depends heavily on the signal strength. If the router is far away from the appliance, there may be problems with the reliability of the connection.

WARNING!

Appliance functions and equipment depend on the model.

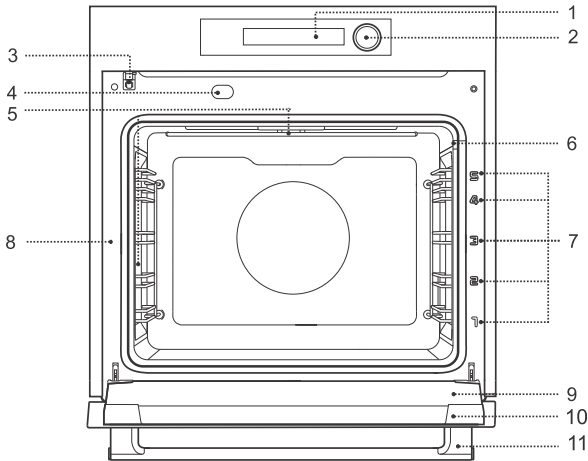

1. User interface
2. Jog dial
3. Locking the door with a switch
4. Automatic steam removal
5. Lighting
6. Food probe socket
7. Guides – rack levels
8. Label
9. Door glass
10. Oven door
11. Door handle

Appliance equipment

Oven door switch

The switch switches off the operation of the heaters and the ventilation in the oven room when the oven door is opened during operation.



Guides

Wire guides – always insert the wire rack and baking tray into the guide.

Fixed pull-out guides – place the equipment on the guide. On the same guide, you can place the rack together with the drip pan.

NOTE: Guides – rack levels are counted from the bottom up.

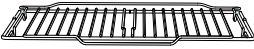
Oven equipment and accessories

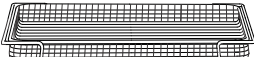
	<p>Wire rack – used for grilling/broiling or as support for a pan, baking tray or baking dish. NOTE: When inserting the wire rack into the guide, always make sure its elevated part is at the back and on the top side. There is a safety latch on the wire rack. Therefore, the wire rack has to be lifted slightly at the front when pulling it out from the oven.</p>
	<p>All-purpose baking tray – a versatile baking tray useful for baking pastries, bakery products, cooking vegetables and all types of meat. It can also be used as a drip tray.</p>
	<p>Airfry grid tray – (baking tray with holes) used for cooking with hot air + top heater (air fry) functions. The holes allow for better air flow around the food and contribute to greater crispness.</p>

Appliance description

Table continued from last page







Food probe - (ΛFOOD PROBE)

It can be used to measure the core temperature of a dish. When the desired temperature is reached, cooking will stop automatically.

Control panel







Key	Use
1. 	The on/off button is for: - switching the oven on and off, - switching to standby mode - forced restart - long press (8 seconds).
2. 	This button is used to: - go back, - close the menu, - cancel a menu or function
3. 	Additional settings button
4. 	Main Menu (HOME) button
5.	Touchscreen for selecting oven settings and viewing the current settings.
6.	Jog dial for selecting and confirming settings on the screen.

NOTE:

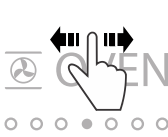
For better key response, touch them with as much surface area of your fingertip as possible and in the center of the jog dial. A sound signal is emitted with each key press (when the function is available).

You can select and confirm the settings on the SCREEN or by using the JOG DIAL.
The selected field turns white.

press	swipe left and right	swipe up and down	turn	pressure
				

Appliance description

Jog dial animations and colours

The jog dial of the oven has an integrated LED ring that clearly shows the current status or operating mode of the oven through different colours and animations.

Colour on the jog dial	Meaning
White colour	Displays the standby mode.
Amber colour	The oven requires the user's attention (e.g. warning or confirmation of a message).
Green colour	Indicates a confirmed setting and shows that the oven is connected to the network.
Red colour	Indicates that the basic cooking mode or the conventional oven is selected.
Turquoise colour	Indicates that the cleaning program is selected.

Colour light stays on - means that the program is running and no additional attention is required.

Colour light flashes softly - draws attention to background processes or required user interaction.

1.	Remove oven utensils and any packaging (cardboard, polystyrene foam, plastic) from the oven.
2.	Wipe the oven accessories and interior with a damp cloth. Do not use abrasive or aggressive cloths or cleaners.
3.	Switch on the oven (see chapter: <i>Switching on for the first time</i>).

Switching on for the first time

Calibration on first-time switch-on - Onboarding

When connecting the appliance to the power mains for the first time or resetting it to factory settings, you will need to perform a calibration procedure when switching on the oven.

The program will guide you through the settings to set up the connection to the mobile app during the calibration. When the oven is connected to the Cloud, the date and time will be updated automatically.

Follow the steps on the display. On the display, first press **Let's get started**.

Swipe through the menu. After you select a setting, press **NEXT**.

1.	Language setting The display shows the default language (English). If the language in which the text is displayed is not suitable, select another language from the drop-down list.
2.	Explanation of the user interface For ease of use, the display shows the button names on the control panel.
3.	Installation and connection to the ConnectLife application The display shows the QR code to install the ConnectLife app. Use the app to control, monitor and remotely access the oven controls from your smart device. Connect to the Wi-Fi network to install software updates: these are useful for enhanced security, new features, improve performance, bug fixes. Press Connect and follow the steps in the app.
4.	Setting the clock Automatic time setting, including time zone and time format (12 or 24 hours) is available when the oven is connected to the internet via the app. If the connection is not established, manual time setting will be required.
5.	Setting the date Select the display format.
6.	Opening the door - Waking up This function can be switched on or off as desired. When switched on, the function allows you to switch the oven on or off automatically by simply opening the oven door.
7.	Calibration with the food probe The calibration procedure ensures the accuracy of the temperature measurement, as it automatically eliminates any deviations (with a maximum of ± 1 °C). As part of the process, a heating process is also carried out, which removes the residues of the production process and any unpleasant odours through a special heating programme at high temperature. This way, the unpleasant smells will not be transferred to the food prepared in the oven.

Before first use

Table continued from last page

The total calibration time is up to 4 hours. In the event that you decide to skip the procedure, the device will not send further pop-up notifications about performing the procedure. Calibration can be done at any time in the settings menu.

NOTE: During the heating process, unpleasant odours or the characteristic "new smell" may come from the oven. Thoroughly ventilate the room throughout the duration of the programme.

Calibration with the food probe

(depending on the model)

During the calibration process, the food probe allows accurate measurement of the temperature at the centre of the oven ($\pm 1^{\circ}\text{C}$).

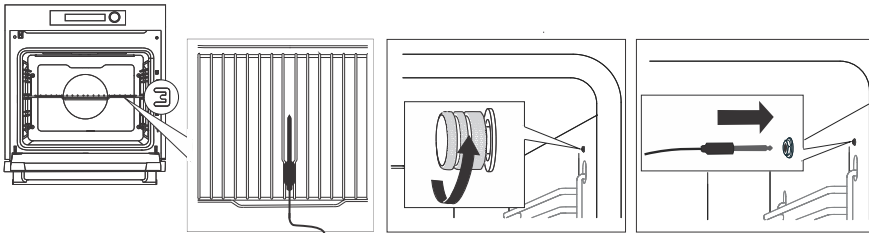

1.	Remove any loose accessories from the oven. Place the wire rack to the third position.
2.	Place the probe in the centre of the rack, with the tip facing the back of the oven.
3.	Unscrew the socket cover (only on some models) on the front in the upper righthand corner of the oven and plug the probe into the socket.
4.	The total calibration process lasts for 4 hours. Do not open the oven door during calibration.
5.	A sound signal is emitted, the calibration is complete. The probe can be switched off and safely put away.

The food probe calibration process can be skipped and performed at a later point in time using the Settings menu.

Standby mode

To save energy, the display will automatically switch off after a few minutes of non-use and enter standby mode with the lowest power consumption. Some settings, such as the clock display or Wi-Fi can be changed in standby mode, but this will increase power consumption. (For more information on energy saving scan the QR code on the rating plate.)

Home menu

By touching  the main menu with all the functions opens on the screen (depending on the model).

Note: swipe left and right to scroll through the menu. Select the desired function by touching the key or pressing the jog dial.

Main functions



OVEN

This allows the even baking and cooking of food using different cooking methods (see chapter: *Manual cooking mode*).



AUTO PROGRAMS

It includes a list of predefined programs that provide optimal results for different types of food and dishes, divided into categories: Single Ingredient, Bakery, Dishes, Ready Meals and Snacks, and Favourites (see chapter: *Auto programs*).



STAGE COOKING

This function allows you to set cooking in three steps. Combine three consecutive cooking steps into one cooking routine (see chapter *Stage cooking*).



COOL DOWN

The function allows you to quickly switch from high to lower temperatures.



CLEANING

These programs make it easier to remove dirty marks from the inside of the oven (see chapter: *Cleaning and maintenance*).



SAVED PROGRAMS

This mode allows you to select programs you have previously saved – up to 50 manually set programs (see chapter: *Save your own oven programs*).



DEFROST

Used for the slow defrosting of frozen food (cakes, pastries, bread and fruit).

Halfway through defrosting, turn the food over, move the pieces around, and separate the pieces if they are stuck to each other.



PRESERVING

Used to heat-treat food to reduce the activity of micro-organisms and enzymes in the food, thus prolonging its shelf-life.



NON FOOD

It is used for reheating cutlery, hot stones and sterilising bottles. You can set the temperature and the heating start and end times.









WARMING

Used to reheat food and keep it warm. You can set the temperature and the start and end times for heating.











Using the oven

Manual cooking mode

1.	Switch on the appliance  . In the main menu, select  OVEN.
2.	Select the cooking system (see the Choosing Cooking Systems table below – depends on the model).
3.	Depending on the choice of cooking system, you will be shown settings for: - temperature - grill power level from 1 to 5 (if you selected the large grill system)
4.	Use quick preheating if you want to heat the oven to the desired temperature as quickly as possible. By touching  you can select preheating. You can also turn it off. When the set temperature is reached, an acoustic signal sounds and the display shows Insert dish, preheating complete. Open the door and insert the dish. Fast Preheat as default - The inside of the oven heats up as soon as possible. The food should not be inserted into the oven during this process. Preheat as default - The inside of the oven heats up quickly and efficiently. The food should not be inserted into the oven during this process. No Preheat as default - Heating starts gradually with the set program, which allows immediate insertion of food for even cooking.
5.	Additionally, you can set: -  Duration (see chapter: <i>Duration of operation - Time function</i>). -  menu (see chapter: <i>Plus menu - additional settings</i>).
6.	To start cooking, touch START  .
Note: On the left of the screen you can press  to see additional information about the system.	

Choosing the baking system

(depending on the model)

Symbol	Use
	<p>Top + Bottom</p> <p>Use this system for conventional cooking on a single rack, making soufflés, and cooking at low temperatures (slow cooking).</p>
	<p>Top 30 + Bottom 70</p> <p>The lower heating element delivers more heat than the upper one. Suitable for cooking dishes on a single rack, such as wet pastries, cakes, and dishes where you want the bottom part to be more cooked.</p>
	<p>Hot Air</p> <p>Hot air allows for better air circulation around the dish. In this way, it dries its surface more and creates a thicker crust. For roasting meat, baking cakes, cooking vegetables and for drying food on one or more racks at the same time.</p>
	<p>ECO Hot Air¹⁾</p> <p>For gentle, slow and even cooking of meat, fish and pastries on one level. This way of cooking retains a higher proportion of water in the meat, which leaves it juicier and softer, while the pastry becomes evenly browned/baked. The used temperature range is between 140 °C and 220 °C.</p>
	<p>Dry Hot Air</p> <p>This allows for a better flow of hot air around the food. Combined with moisture extraction, it provides dry air that more quickly bakes and browns food on one or more racks at the same time.</p>
	<p>Hot Air + Bottom</p> <p>Perfect for making pizza and pastries with a higher water content. For cooking on one level when you want your dishes cooked and crisp as quickly as possible.</p>
	<p>Top + Bottom + Fan</p> <p>For even cooking of dishes on one level and making souffles.</p>
	<p>Air Fry</p> <p>This cooking method gives the food a crispy crust, without added fat. It is a healthy version of "fast food" with a lower calorie content. Suitable for small cuts of meat, fish, vegetables and pre-cooked frozen products (French fries, chicken medallions, etc.). For best results, we recommend placing your food in a cold oven. If the oven is preheated, set the temperature up to 20 °C higher than indicated on the food packaging.</p>
	<p>Large Grill</p> <p>For cooking large quantities of flat foods, such as toasted bread, canapees, grill sausages, steaks, fish, skewers, as well as for gratinating and achieving a nice crispy crust. The heaters mounted on the top of the oven cavity heat the entire surface evenly.</p>
	<p>Large Grill + Fan</p> <p>For roasting poultry and grilling large pieces of meat.</p>

Using the oven

Table continued from last page

Symbol	Use
	Bottom Heat Suitable for leavening dough and extra cooking on the underside.



¹⁾ This function is used to determine the energy efficiency class according to EN 60350-1.

Duration of operation - Time function

In this mode, you can specify the duration of operation for the oven.

INFORMATION!

If the appliance has been connected to the cloud, the time and date are automatically set.

1.	To select the timer function, press  .
2.	Select the duration for oven operation.
3.	To start cooking, touch START  .

Plus menu - additional settings

The **+** function provides additional settings. The menu varies depending on the control options available at the time.





	Start End Use this mode when you want the food in the oven to start cooking after a time delay (see chapter <i>Setting a delayed start</i>).
	Number of Trays This function is available when using hot air systems and allows you to adjust the air circulation according to the number of trays in the oven. The system automatically adjusts the airflow according to the selected option and ensures optimal cooking results.
	Gratin This function is used in the last phase of cooking, when we add a dressing/topping to the dish or we want to additionally brown the top. When using the gratin function, a crispy golden yellow crust is formed on the dish, which protects the food from drying out, and at the same time gives the dish a pleasing appearance and a better taste (see chapter <i>Gratin</i>).
	Reduce Moisture This mode allows the door to be automatically opened and closed in order to release moisture inside the oven during cooking (see chapter: <i>Reducing humidity in the oven</i>).
	Food Probe The food probe allows for accurate monitoring of the core temperature of food during cooking (see chapter: <i>Food Probe</i>).

Table continued from last page

	<p>Add Stage Three-step cooking setting with various parameters (see chapter <i>Stage cooking</i>).</p>
	<p>Save In this mode you can save your favourite settings (see chapter <i>Save your own oven programs</i>).</p>

Setting a delayed start

INFORMATION!

Delayed start cannot be set on cleaning programs.

In the menu **+** select . There are two types of delayed start:

- 1. Changing the start time**
If you have not set the duration of operation in the basic settings, you can set a start delay. Set the desired start of cooking setting and confirm your choice.
- 2. Changing the start or end time**
In the basic settings, first set the cooking duration.
In the menu **+** select and you can set the time at which you want the dish to be ready. Confirm your selection. The program automatically calculates the start time for cooking.
- 3.** To start cooking, touch **START ►** .
The screen will show the cooking start time.
The oven goes into standby mode until the start time. The selected settings are automatically switched on and off at the selected times.

After the set time has expired, the oven stops working automatically. A short beep will be emitted. You can reset the selected setting by pressing **×** .

Gratin

This function is used in the last phase of cooking, when we add a dressing/topping to the dish or we want to additionally brown the top.

INFORMATION!

This function can be used if you have set the cooking duration.

- 1.** In the menu **+** select .
- 2.** Set the operating time of the au gratin function (max. 15 min). The function will be activated at the end of cooking when the set cooking time has elapsed. Confirm with **✓** .
- 3.** To start cooking, touch **START ►** .
- 4.** The function can also be switched off while it is in operation. Turn off cooking by pressing **<** .

Using the oven

WARNING!

Control the cooking. When using the au gratin function, the oven reaches high temperatures. The au gratin function works for a maximum of 15 minutes, then the oven switches off automatically.

Reducing humidity in the oven

The function allows the door to be automatically opened and closed during appliance operation. It is recommended when the user wants to release excess steam during cooking, so that the dishes cook faster and develop a crunchy crust.

Moisture reduction is recommended when preparing:

- bakery products (towards the end of baking): for a nicely baked and crisp crust;
- meat (towards the end of cooking): to create a nicely cooked and crisp surface;
- vegetables: use the function several times during cooking to release excess moisture from the oven;
- french fries, biscuits and similar pastries (towards the end of baking): for an improved texture.

1.	In the menu + select  .
2.	Set the time for the first release of steam and confirm the selection.
3.	Now set a time for the second and third release. The number depends on the duration of operation.

The oven door automatically opens and closes according to the time that has been set. You can reset the selected setting by pressing **×** .

WARNING!

The door closes automatically when opened. Manual pushing or forced closing may damage the mechanism.

Stage cooking

This function allows you to set the cooking in three steps (combine three consecutive cooking steps in one cooking process).





INFORMATION!

This function can be selected in the **+** menu or in the Main Menu.

1.	Step 1 Press  Add Stage . You can select the settings for the first step: cooking system, temperature and cooking duration. You can also choose quick preheating. Confirm your selection. NOTE: You can also set the first step in the basic settings if you select a cooking duration.
2.	Step 2 Select the settings for Step 2 and Step 3. You can also change the steps prior to the start of cooking.
3.	To start cooking, touch START ▶ . The oven initially starts with the settings for Step 1.
NOTE: You can remove an individual step by touching × .	

Save your own oven programs





This allows you to save your favourite and most frequently used settings in memory and use them again at another time. Up to 50 presets can be stored.

1.	Saving in settings From the settings, you can save your selected parameters in your preset and use them again in the future. By pressing  you open the keyboard for naming your preset. There is no limit on the length of the name. Confirm with  .
2.	Saving the setting after cooking has ended. After completion of the operation, the screen shows  . Press this key to save the preset. The main menu appears on the screen.
3.	Show already saved settings You can re-select your favourite recipes by entering the Main Menu and selecting  SAVED PROGRAMS . The names of all saved recipes are displayed. NOTE: You can also change the preset values for already saved recipes and save them under a new name after cooking.
4.	Deleting previously saved settings Select the preset. Press + and select  . You will see a warning on the screen. Confirm your selection.

Using the oven

Auto programs





The program offers you a large selection of recipes that were approved by chefs and nutritionists.

1.	Switch on the appliance  . In the main menu, select  AUTO PROGRAMS.
2.	Select the type of food and then the selected dish. Confirm with  . The recipes have a predetermined system, temperature and cooking time. Auto programs are classified into the main categories: <ul style="list-style-type: none">• Single ingredients: programs designed to prepare individual foods such as meat, vegetables, eggs, or fruits.• Dishes: programs for dishes that include more ingredients and require more complex preparation.• Bakery: programs for bakery products such as bread and various types of pastry.• Ready meals and snacks: programs for frozen or pre-prepared dishes and cooked snacks such as fries or popcorn.• Favourites: a selection of programs that you mark as favourites from the categories above. <p>NOTE: For some dishes, you can also change the programs parameters.</p>
3.	Additionally, you can set: -  menu (see chapter: <i>Plus menu - additional settings</i>).
4.	The auto program allows you to select additional functions for the selected dish (<i>See later chapters</i>).

Note: On the left of the screen you can press  to see additional information about the program.

Search

The search function allows you to search by entering a word or part of a word, such as the name of an auto program or an ingredient.

1.	Switch on the appliance  . In the main menu, select  AUTO PROGRAMS.
2.	Press  and write the name of the dish or part of the name of the dish you are looking for.
3.	Confirm your selection with  .

Search results are shown automatically after just one character has been entered.

INFORMATION!

If the browser does not find any matching results, a "no results" message is displayed.

Add to favourites

Favourited programs provide quick access to frequently used routines.





1.	Switch on the appliance  . In the main menu, select  AUTO PROGRAMS.
2.	Select the type of food and then the selected dish.

Table continued from last page





3.	Press + and select  . Confirm your selection.
To delete a preset, select  .	

INFORMATION!

The Favourites list is displayed in alphabetical order.

Custom program

With this function, you can change the programs parameters according to your preferences.

1.	Switch on the appliance  . In the main menu, select  AUTO PROGRAMS .
2.	Select the type of food and then the selected dish.
3.	Press + and select  . You are shown options and presets that allow you to adjust and manage key parameters such as temperature, system, humidity and power, according to your needs.
4.	Confirm your selection with  .





INFORMATION!

Custom settings can be saved as presets.

Extra functions







(depending on the model)

A number of additional features can be selected. By pressing  the main menu appears on the screen.

	DEFROST
	<p>Defrost with Fan</p> <p>This is used to slowly thaw frozen food (cakes, pastry, bread, rolls, and deep-frozen fruit). Halfway through the defrost time, the pieces should be turned over, stirred and separated if they were frozen together.</p>
	PRESERVING
	<p>Drying</p> <p>Function intended for drying out food. Suitable for drying fruits and vegetables.</p>
	<p>Drying Herbs</p> <p>Function intended for drying out food. Suitable for drying herbs.</p>

Using the oven

Table continued from last page

	Pasteurization The function prevents the growth of bacteria using heat. Suitable for juices.
	Canning For sealing jars for preserved foods (such as compote, jam, applesauce, tomato sauce, pickled food, preserved vegetables, etc.).
NON FOOD	
	Plate Warming Use this function to warm crockery before serving food on it so that the food stays warm for longer. You can set the temperature and the start and end times for heating.
	Hot Stones Used for preparing hot stones. Place the clean stones on the baking tray and place on the second rack.
	Sterilizing For non-food items such as glass jars, baby bottles, etc.
WARMING	
	Reheat with Hot Air This function enables gentle reheating of prepared dishes. Avoid opening the door unnecessarily during operation.
	Keep Warm Used to keep food warm. You can set the temperature and the start and end times for heating.
Note: some features allow you to select pre-defined programs.	

Starting the cooking process

Start cooking by pressing **START ►** .

The following parameters appear on the display (depending on the selected settings):

- cooking system
- the current and set temperatures
- duration of operation
- delayed start

End of cooking by touching

After cooking is completed, the display shows **ENJOY!**. A beep sounds.

You can also cancel the operation by pressing < .

By pressing the button, you can select a new setting.

Menu content varies depending on the control options available at that time.

Resume Program	By selecting this, you extend the cooking by 5 minutes. The duration and cooking system can be set.
Save	The mode allows you to save the selected settings to your favourites and use them again later (if you used manual cooking mode) (see chapter: <i>Save your own oven programs</i>).
Cool Down	This mode allows you to quickly switch from high to low temperatures.
Keep Warm	This mode allows you to maintain the heat level in the oven (the food in the oven stays warm).
Remove steam when program ends	Automatic door opening enables automatic steam removal. Note: the screen caption appears if you do not have this function selected in the General settings (see chapter: <i>General settings</i>).

INFORMATION!

After the operation is completed, the cooling fan will continue to operate for some time.

Condensation in the oven cavity and on the inner door after a baking program is a normal occurrence and does not affect the baking result. After cooking with steam, however, more condensation is present because the system uses water during the steam process. We recommend wiping the oven interior clean after the program ends, before the next use.

WARNING!

After a power failure or switching off the appliance, the settings of the additional functions are retained.

By pressing  you enter the selection menu.



REMOTE START

By pressing this button you can activate the remote control (see chapter: Wi-Fi operation).



OVEN LIGHT

Press this button to switch the oven light on or off.



REMINDERS

The alarm operates independently of the operation of the oven. The maximum possible setting is 24 hours.

You can set three different alarms. To turn off the alarm, set the time to 0:00.

NOTE: If the appliance is switched off, the alarm will still be active.



DISPLAY LOCK - AUTOMATE

Activate/deactivate the oven safety key lock to protect the oven from accidental use.

Lock the screen by touching the key.

To unlock the screen, touch the screen or any key. Swipe the screen from left to right and then press the **BUTTON**.

- If the lock is activated with no timer function engaged (only clock is displayed), then the oven will not operate.
- If the lock is activated after a timer function has been set, then the oven will operate normally; however, it will not be possible to change the settings.
- When the keys are locked, you cannot change the cooking systems or additional functions. You can only turn off the cooking.
- The keys remain locked even after the oven is switched off. To select a new system, you must deactivate the lock.



SETTINGS

On pressing the button, you can choose between different settings and adjust them (see table below).

By pressing  you can select and edit different settings.



LANGUAGE - TIME

Select your preferred language, date and time from the drop-down list.



COOKING

You can choose between different settings:

- **DEFAULT PREHEAT**
The function automatically activates **Fast Preheat as default**, where the inside of the oven is heated as soon as possible, or **Preheat as default**, where the inside of the oven is heated quickly and efficiently. When you select **No Preheat as default**,

General settings

Table continued from last page













	<p>heating starts gradually with the set program, which allows immediate insertion of food for even cooking.</p> <ul style="list-style-type: none">• COOKING SETTINGS You can choose between the general settings or your selected most recent settings, which are retained at the end of operation.• REMOVE STEAM WHEN PROGRAM ENDS The function allows the door to be opened automatically and allows steam to be removed automatically.• REMINDERS You can select a reminder when the desired temperature is reached and a reminder at the end of cooking (from one to five minutes).• CALIBRATION AND BURN-IN The calibration process takes 4 hours. You activate it by pressing START.
	<p>MODES</p> <p>Upon confirming your selection, you will see a column with active modes on the righthand side of the menu. By tapping on this column, the screen will display the settings that can be changed (ECO, NIGHT MODE, SABBATH, SHOP MODE).</p>
	<p>CONTROL</p> <p>You can choose between different settings:</p> <ul style="list-style-type: none">• DOOR OPEN - WAKE UP To always display the home screen when the door opens, select On. Power consumption may increase when this function is switched on.• START UP SCREEN To make the display visible even after the oven is switched off, select On.• INACTIVITY Select the length of time you want the screen to stay on during inactivity.• CLOCK SCREEN VISIBILITY The function allows you to turn the daytime on and off.• DISPLAY LOCK Select On if you want the display to lock while the oven is not working.• DOOR LOCK - AUTOMATE Select On if you want the oven door to lock while not in operation.
	<p>DISPLAY</p> <p>Select the desired screen brightness.</p>
	<p>SOUND</p> <p>You can choose between different sound modes.</p>
	<p>LIGHT</p> <p>You can set the light operating time. You can change the light intensity from 10% to 100% and the colour temperature from 2700K to 5000K (from warm yellow to cold white).</p>
	<p>CONNECT</p> <p>You can set up the connection, oven connectivity and additional users.</p>

Table continued from last page









	<p>UPDATE - RESET The function allows you to reset to factory settings and update.</p>
	<p>INFO - SUPPORT The function provides assistance to the user with instructions for use and information about the device.</p>

By touching  you can select and edit different functions. The selected function is marked with ✓.

	<p>SABBATH The Sabbath function allows food in the oven to stay warm without having to switch the oven on and off. Set the duration (24 or 80 hours) and temperature. By touching x the countdown begins. All sounds and operation are switched off, except for the key x. NOTE: In case of a power outage, Sabbath mode will be deactivated and the oven will return to its initial state.</p>
	<p>ECO ECO mode is designed to increase energy efficiency by automatically using predefined ECO settings. This function reduces energy consumption while maintaining full functionality for cooking and cleaning programs, providing an environmentally friendly solution without compromising on performance.</p>
	<p>NIGHT MODE The function automatically reduces brightness from higher to lower intensity and turns off the daytime display and acoustic signals. To activate the night mode, specify the start and end times. Turn off the night mode by pressing x.</p>
	<p>DEMO Demo mode is an exhibition setting in which the appliance simulates the operation with virtual values and allows you to change and save the settings. When deactivated, all configurations are retained and the appliance returns to normal operation.</p>

Wi-Fi management

Using Wi-Fi

1.	Switching on the Wi-Fi module Enter the additional menu. Touch  , select CONNECT and then select the option CONNECT OVEN . Turn on the Wi-Fi connection by toggling the switch to ON .
2.	Connecting the appliance Select CONNECT OVEN . In the additional menu, press  to select  . Then, under Wi-Fi, select CONNECT . Follow the steps in the ConnectLife app. When the connection is successful, the display shows " Your oven is now connected ". This process is limited to 5 minutes. NOTE: The device is connected to the user account in the smart app after the connection is established.
3.	Connecting additional users Use this setting to connect additional users to the appliance using ConnectLife . In the additional menu, touch  to select  . Choose the option CONNECT . Select CONNECT USER and then PAIR . To continue setting up your device, follow the instructions in the ConnectLife app. This process is limited to 3 minutes.
4.	Remove all connected users Use this setting to remove all connected users from the app. ConnectLife In the additional menu, touch  to select  . Select the option CONNECT . Touch CONNECT USER and then UNPAIR ALL . After confirming the selection, the display shows All users/devices are now unpaired .
5.	Switching off the Wi-Fi module In the additional menu, touch  to select  . Choose the option CONNECT OVEN . Turn off the Wi-Fi connection by toggling the switch to OFF .

INFORMATION!

Connecting is a one-time process.

Only reconfigure the connection if you change the router or change the password on your local network.

Managing the oven remote control

WARNING!

The remote monitoring function via a mobile device should not be used to replace direct personal supervision of the cooking process in the oven. Always regularly check, in person, what is actually going on in the oven.

In the additional menu, press . If the appliance is not connected to the Wi-Fi network, the shortcut for connecting the appliance is displayed. Otherwise, a menu is displayed allowing you to select the duration of remote oven control **Always on** or **24 hours**. After confirming one of the options, the following pop-up is displayed **Remote control is on**.

The display shows the  symbol to indicate the possibility of remote control via **ConnectLife**.





INFORMATION!

For safety reasons, some functions are not available via remote access.

- Cancellation or completion of the baking program or process is the only option that remains available regardless of whether remote control is enabled or not.
- Remote control is disabled when using a microwave system (not applicable to combined microwave systems).

WARNING!

Always make sure the oven is used correctly and in compliance with the instructions, especially when using remote control. Do not run the oven via remote access unless you are certain about what exactly is in the oven.

Wi-Fi status on the display unit		Cause
REMOTE (OFF)	REMOTE (ON)	
		Wi-Fi disabled (OFF).
		Symbol flashes: - Wi-Fi is ON, but not connected to the server or to the cloud (including when connection to the router or cloud is temporarily lost).
		

General tips and advice for baking

Equipment:

- Use equipment made of heat-resistant non-reflective materials (supplied baking trays and dishes, enamel-coated cookware, tempered glass cookware). Bright-coloured materials (stainless steel or aluminium) materials reflect heat. As a result, thermal processing of food in them is less effective.
- Always insert the baking sheets and trays to the end of the guides. When baking on the wire rack, place the baking dishes or trays in the middle of the rack.
- Do not place the baking trays directly onto the oven cavity bottom.
- Do not cover the oven cavity bottom or the wire rack with aluminium foil.
- Always place the baking dishes onto the wire rack.
- If you are using parchment paper, make sure it is resistant to high-temperatures. Always trim it accordingly. Parchment paper prevents the food from sticking to the baking tray and makes it easier to remove the food from the baking tray.
- When cooking directly on the wire rack, insert the all-purpose baking tray one level lower to serve as a drip tray.

Food preparation:

- In the event that **Top + Bottom** the system delivers food that is undercooked from the underside, adjust the cooking level, temperature and time or use the following system **Top 30 + Bottom 70**.
- For optimum food preparation, we recommend observing the guidelines specified in the cooking table. Choose the lower specified temperature and the shortest specified cooking time. When this time expires, check the results and then adjust the settings as necessary.
- When cooking according to recipes from older cookbooks, use the bottom and top heater system (as in conventional ovens) and set the temperature 10 °C lower than specified in the recipe.
- When cooking larger cuts of meat or pastry with higher water content, a lot of steam will be generated inside the oven, which in turn may condense on the oven door. This is a normal phenomenon which will not affect the operation of the appliance. After the cooking process, wipe the door and the door glass dry.

















Efficient use of energy

- Preheat the oven only if indicated in the recipe or in the tables in this instruction manual. If you are using quick preheating, do not put food in the oven until the oven is fully heated, unless otherwise recommended. When heating an empty oven, a lot of energy is consumed, so if possible, we recommend that you prepare several dishes in a row or several dishes at the same time.
- Remove all unnecessary equipment from the oven during baking
- Unless it is absolutely necessary, do not open the oven door during baking.
- With longer cooking programs, you can switch off the oven approximately 10 minutes before the end of cooking time to make use of the accumulated heat.

General tips and advice for baking











Cooking table

NOTE: Dishes requiring a fully pre-heated oven are indicated with a single asterisk in the table. *
Dishes that only require a 5-minute preheating of the oven are indicated with two asterisks. **. In
this case, do not use the quick preheating mode.

Dish	 cm			 °C	 min
PASTRY AND BAKERY PRODUCTS					
pastry/cakes in moulds					
sponge cake	60/45	1		160-170	30-40
pie with filling	60	2		170-180	60-80
	45	1			
marble cake	60/45	2		180-190	50-70
cake with leavened dough, Gugelhupf (Bundt cake, pound cake)	60/45	1		170-180	50-60
open pie, tart	60	3		170-180	35-45
	45	2			
brownies	60	2		170-180	35-45
	45				30-40
pastry on baking trays and dishes					
strudel	60/45	2		170-180	50-60
strudel, frozen	60/45	2		200-210	80-100
sponge roll	60	3		160-170	30-40
	45	1			
buchteln	60/45	2		180-190	30-40
biscuits, cookies					
cupcakes	60	3		140-150**	25-35
	45	2		160-170	20-30
yeast-leavened small pastry	60	3		170-180	20-30
	45	2			













General tips and advice for baking

Table continued from last page

Dish	 cm			°C	⌚ min
yeast-leavened small pastry, 2 levels	60	2+4		160-170	20-30
	45	1+3			30-40
puff pastry	60	3	—	190-200	10-20
	45	1			
puff pastry, 2 levels	60	2+4		160-170**	15-25
	45	1+3			10-20
cookies/biscuits					
piped cookies	60	3		140-150	30-40
	45	2		140-150**	35-45
cookies/biscuits	60	3		160-170**	15-25
	45	2			
biscuits, 2 levels	60	2+4		160-170**	15-25
	45	1+3			
meringue	60	2	—	80	110-130
	45				
meringue, 2 levels	60	2+4		100**	110-130
	45	1+3			
macarons	60	3	—	140	10
	45	2		130	15-20
bread					
rising and proofing	60	2		35	30-60
	45	1			
bread on a baking tray	60	1	—	220 **	15
				190	25-40
	45	2		220 **	15
				190	25-40
bread in a tin	60	1	—	230	20-25
				180	20-25
	45			200 **	40-50











General tips and advice for baking

Table continued from last page

Dish	 cm			°C	⌚ min
flatbread (focaccia)	60/45	2	— —	220 **	20
				180	5-15
fresh bread rolls (Semmel/morning rolls)	60	3	— —	200-210 **	15-25
	45	2			
fresh bread rolls (Semmel/morning rolls), 2 levels	60	2+4		200-210 **	20-30
	45	1+3			15-25
toast	60	5		L5	5-15
	45	4			
open sandwiches	60/45	4		L2	3-10
pizza and other dishes					
homemade pizza	60/45	1		max **	4-12
homemade pizza, 2 rack levels	60	2+4		max	15-25
	45	1+3			20-30
frozen pizza	60	2		210-220	15-20
	45				15-25
frozen pizza, 2 levels	60	2+4		210-220	15-25
	45	1+3			
savoury pie, quiche	60/45	2		190-210	50-60
burek	60	1	— —	200-210	35-45
	45				40-50
MEAT					
beef and veal					
beef roast (loin, rump), 1.5 kg	60/45	2	— —	160-170	160-190
sirloin, medium done, 1 kg	60/45	2	— —	180-190	35-45
beef roast, slow cooked	60	2	— —	100-120	150-240
	45	1			
beef steaks, well done, 3 cm thickness	60/45	3		L3	20-30

















General tips and advice for baking

Table continued from last page

Dish	 cm			°C	⌚ min
burgers, thickness 3 cm	60	4		L4	30-40
	45	3			
veal roast, 1.5 kg	60	2	—	190-200	90-110
	45	1			
pork					
pork roast, rump, 1.5 kg	60	3	—	190-200	70-100
	45	2			85-100
pork roast, shoulder, 1.5 kg	60	2	—	190-200	90-110
	45	1			
pork loin, 400 g, slow cooked	60	2	—	100-120	200-300
	45				250-350
pork roast, slow cooked	60	2	—	100-120	150-240
	45	1			
pork ribs, slow cooked	60	3	—	120-140	210-310
	45	2			
pork chops, thickness 3 cm	60	4		220-230	25-35
	45	3			
poultry					
poultry, 1.2–2.0 kg	60/45	2		210-220	50-70
poultry with stuffing, 1.5 kg	60/45	2		170-180	110-130
poultry, breast	60	3		170-180	60-90
	45	2			
chicken thighs	60	3		210-220	35-45
	45	2			
chicken wings	60	3		210-220	35-45
	45	2			
poultry, breast, slow cooked	60	3	—	100-120	40-80
	45	2			
meat dishes					















General tips and advice for baking

Table continued from last page

Dish	 cm			°C	⊖ min
meat loaf, 1 kg	60	2		180-190	55-65
	45				50-60
grill sausages, bratwurst	60	4		L4	30-40*
	45	3			20-30*
FISH AND SEAFOOD					
whole fish, 350 g	60	4		200-220**	20-30*
	45	3			
fish fillet, thickness 1 cm	60	4		210-220	5-15
	45	3			
fish steak, thickness 2cm	60	4		160-170	15-25
	45	3			
scallops	60	4		220-230 **	5-15
	45	3			
shrimps	60	4		L4	20-30
	45				15-25
VEGETABLES					
baked potatoes, wedges	60	3		190-210	40-50*
	45	2			
baked potatoes, halved	60	3		200-220	30-40
	45	2			
stuffed potato (jacket potato)	60	3		200-210	25-35
	45	2			
French fries, home-made	60	3		210-220	15-30
	45	2			
mixed vegetables, wedges	60	4		200-210	10-20*
	45	2			15-25*
stuffed vegetables	60	2		200-210	40-50
	45				
CONVENTIONAL PRODUCTS – FROZEN					

General tips and advice for baking

Table continued from last page

Dish	 cm			°C	⌚ min
French fries	60	2		200-210	30-40*
	45				
french fries, 2 levels	60	2+4		200-210	30-40*
	45	1+3			40-50*
chicken medallions	60	3		210-220	25-35*
	45	2			20-30*
fish fingers	60	3		210-220	25-35*
	45	2			20-30*
lasagne, 400 g	60	2		210-220**	30-40
	45				40-50
diced vegetables	60/45	2		190-200	35-45
croissants	60	3		100	20
				170	15-20
	45	1		100	20
				170	15-20
BAKED PUDDINGS, SOUFFLÉS AND DISHES AU GRATIN					
potato moussaka	60/45	2		180-190	50-60
lasagne	60/45	2		180-190	45-55
sweet baked pudding	60	2		170-180	40-50
	45				35-45
sweet soufflé	60	3	—	180 **	16-20
	45	2			
dishes au gratin	60	/	~~~~	L4-L5	3-10
	45				
stuffed tortillas, enchiladas	60/45	2		180-190	10-20
grilling cheese	60	4	~~~~	L3	15-25*
	45	3			10-15*

General tips and advice for baking

Cooking with a food probe (FOOD PROBE) (depending on the model)

The food probe allows for accurate monitoring of the core temperature of the food during cooking.

⚠ WARNING!

The food probe should not be in direct vicinity of the heating elements.

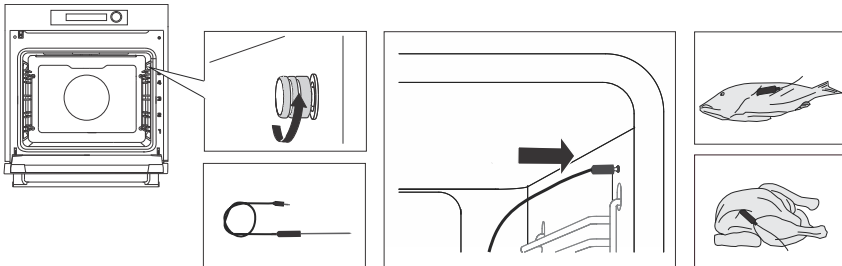

1. Stick the metal end of the probe into the thickest part of the food.
NOTE: To enter the cooking process with the food probe, the current cooking process must first be interrupted and then the food probe must be plugged into the socket. By inserting the probe into the socket, the previously set functions on the oven are deleted.
2. Unscrew the socket cover in the upper righthand corner of the front of the oven (depending on the appliance model) and plug the probe into the socket.
 - In manual mode, press **+** and select . Set the cooking temperature (up to 200°C). Also determine the core temperature of the food (in the range from 30 to 99 °C).
 - In automatic mode, first select the dish and then the probe program. The presets use a predetermined system, temperature and cooking time. You can change the degree of browningNOTE: When using the probe, setting the cooking time is not possible.
3. To start cooking, touch **START ▶**.
During the cooking process, set and current food core temperature alternate on the display unit. You may change the cooking temperature or the target food core temperature during the cooking process.
4. When the set core temperature is reached the oven will stop. An audible signal will be heard, which you can silence by pressing any button. Otherwise, the audible signal will turn off automatically after one minute.

💡 INFORMATION!

The food probe cannot be used simultaneously with the gratin function.

Correct use of the probe, by type of food:

- poultry: stick the probe in the thickest part of the breast;

General tips and advice for baking

- red meat: stick the probe into a lean part that is not marbled with fat;
- smaller chunks with bone: stick them into an area along the bone;
- fish: stick the probe behind the head, towards the spine.

WARNING!

After use, carefully remove the probe from the food and socket, clean it, and tighten the socket cover.

Recommended doneness levels for different types of meat

Type of food	blue (raw) [°C]	medium rare [°C]	medium [°C]	medium well [°C]	well done [°C]
BEEF					
beef, roast	46-48	48-52	53-58	59-65	68-73
beef, sirloin	45-48	49-53	54-57	58-62	63-66
roast beef/rump steak	45-48	49-53	54-57	58-62	63-66
burgers	49-52	54-57	60-63	66-68	71-74
VEAL					
veal, sirloin	45-48	49-53	54-57	58-62	63-66
veal, rump	45-48	49-53	54-57	58-62	63-66
PORK					
roast, neck	/	/	/	65-70	75-85
pork, loin	/	/	/	60-69	/
meat loaf	/	/	/	/	80-85
LAMB					
lamb	/	60-65	66-71	72-76	77-80
MUTTON					
mutton	/	60-65	66-71	72-76	77-80
GOAT MEAT					
goat	/	60-65	66-71	72-76	77-80
POULTRY					
poultry, whole	/	/	/	/	82-90
poultry, breast	/	/	/	/	62-65
FISH AND SEAFOOD					
trout	/	/	/	62-65	/

General tips and advice for baking

Table continued from last page

Type of food	blue (raw) [°C]	medium rare [°C]	medium [°C]	medium well [°C]	well done [°C]
tuna	/	/	/	55-60	/
salmon	/	/	/	52-55	58-60

Cleaning and maintenance

WARNING!

Be sure to unplug the appliance from the power supply and wait for the appliance to cool down.

Children should not clean the appliance or perform maintenance tasks without proper supervision.

- For easier cleaning, oven cavity and baking tray are coated with special enamel for a smooth and resistant surface.
- Regularly clean the appliance and use warm water and hand dishwashing liquid to remove larger impurities and limescale. Use a clean soft cloth or sponge cloth.
- Never use aggressive or abrasive cleaners and accessories (abrasive sponges and detergents, stain and rust removers, scrapers for glass ceramic plates).
- Food residue (fat, sugar, protein) can ignite during the use of the appliance. Therefore, remove larger chunks of dirt from the oven interior and accessories before each use.
- Oven equipment is dishwasher-safe.

Exterior of the appliance	Use hot soapy water and a soft cloth to remove impurities and wipe the surfaces dry.
Interior of the appliance	For stubborn dirt or grime, use conventional oven cleaners. After using such agents, wipe the appliance thoroughly with a wet cloth to remove any residual cleaning agents.
Utensils and guides	Clean with hot soapy water and a damp cloth. In case of persistent dirt, we recommend prior soaking and the use of a brush.



If the cleaning results are not satisfactory, repeat the cleaning process.

WARNING!

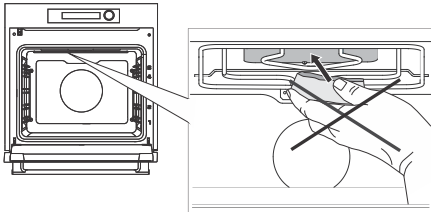
Do not use corrosive, abrasive, or aggressive cleaning agents when cleaning the oven's front panel. Such agents may damage the surface, cause scratches, or permanently alter its appearance.



Never use aggressive cleaners, abrasive cleaners or sponges, stain and rust removers etc. on the oven cavity ceiling cover.

By touching  you open the main menu with the basic functions. Select  **CLEANING.**

Automatic oven cleaning – pyrolysis

WARNING!

Be sure to unplug the appliance from the power supply and wait for the appliance to cool down.

Children should not clean the appliance or perform maintenance tasks without proper supervision.

Thanks to the high temperatures, the function allows for easy cleaning of the interior of the appliance. During cleaning, fat residues and other impurities are incinerated and creamated.

There are three pyrolysis (cleaning intensity) levels available, with varying duration of the process:

Level	Cleaning purpose	Program duration
Low	For minor impurities	2 h
Medium	For noticeable major impurities	2hrs 30mins
High	For stubborn and persistent (older) impurities	3 h

NOTE: The more stubborn the dirt, the higher the level that should be selected.

Preparing for pyrolytic cleaning

Based on an average oven usage rate, we recommend pyrolytic cleaning once a month.

- Remove all equipment from the oven, including the rack guides.
- Remove all visible dirt and food residue from the oven.
- Only start pyrolytic cleaning when the appliance is cooled.

INFORMATION!

If you are not happy with the cleaning results, we recommend repeating the process.

1.	Select the function  Pyrolysis and press START ▶ .
2.	The display shows three cleaning levels and the duration. Use the buttons to select the cleaning level (see table above).
3.	The oven door locks automatically after a certain time for your safety.
4.	When the program is completed, the information infoPyroLock is retained on the display and a short beep will be emitted.
5.	When the pyrolytic cleaning process is complete and the oven has cooled down, the oven door will be unlocked automatically. Once the oven cavity has fully cooled down, wipe it with hot soapsuds and a soft cloth to remove any residue (e.g. ashes).

Cleaning and maintenance

WARNING!

During pyrolysis, unpleasant odours and smoke, as well as irritating vapours and gases, may be emitted. Therefore, make sure that the room is well-ventilated during the procedure and do not stay in that room for prolonged periods of time. Do not allow children or pets to come close to the oven.

During the pyrolysis process, food and fat residues may ignite. Therefore, remove all impurities from the oven interior before starting the process.

Appliance exterior will heat up to a high temperature during the pyrolytic cleaning process. Do not touch the oven door and never hang and combustible objects, such as kitchen cloths or towels, on the door handle.

Do not attempt to open the door while it is locked (during pyrolytic cleaning and while the appliance is cooling down after the process)! The cleaning process may be terminated and there is a risk of burns!

Small animals or pets can be particularly sensitive to any fumes. We recommend removing them from the room during the pyrolytic cleaning process and ventilating the room thoroughly once the cleaning process is complete.

Using the Aqua Clean function to clean the oven

This program makes it easier to remove any stains from inside the oven.

The function is the most effective if used regularly, after each use.

Before running the cleaning program, remove all large visible chunks of dirt and food residues from the oven cavity.

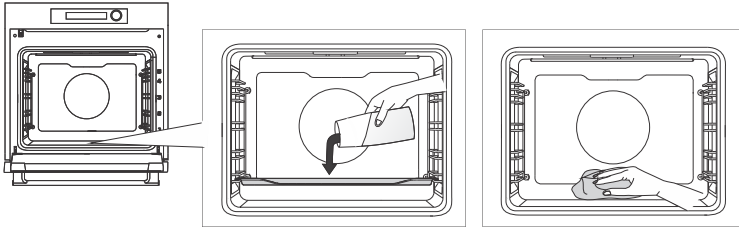

WARNING!

Use the Aqua Clean system when the oven has fully cooled down.

- | | |
|----|---|
| 1. | Place the baking tray in the first guide and pour 0.4 L of warm water into it. |
| 2. | Select the function  Aqua Clean and press START ► . |
| 3. | To begin cleaning, press START ► .
The program will run for 30 minutes. At the end of the program, the display will show FINISHED . |
| 4. | When the program is completed, carefully remove the baking tray, using oven mitts (there can still be some water on the baking tray). Wipe down the stains with damp cloth and soapsuds. Thoroughly wipe the appliance with a wet cloth to remove all cleaner residue.
If the cleaning process is not successful (in case of particularly stubborn dirt), repeat it. |

Removing wire and fixed pull-out (extendible) guides

Use conventional cleaning products to clean the guides.

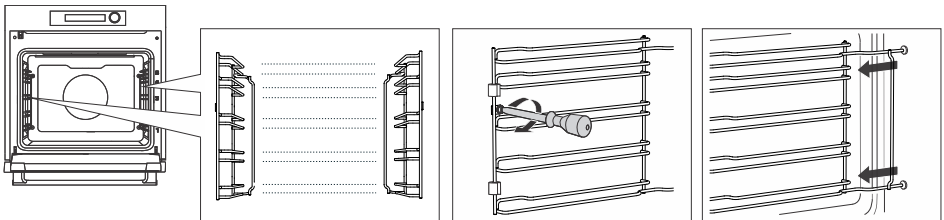

- | | |
|----|---|
| 1. | Use a screwdriver to remove the screw (you can also use a suitable coin that fits the indentation in the screw head). |
| 2. | Remove the guides from the holes in the back wall. |

Cleaning and maintenance

Table continued from last page

NOTE: Take care not to lose the spacers fitted on the guides. You have to reinstall them after cleaning. After cleaning, re-tighten the screws on the guides with a screwdriver. When replacing the guides, make sure you mount them on the same side they were installed on prior to removal.

💡 INFORMATION!

When removing the guides, take care not to damage the enamel coating.

Removing and replacing the oven door and glass panes

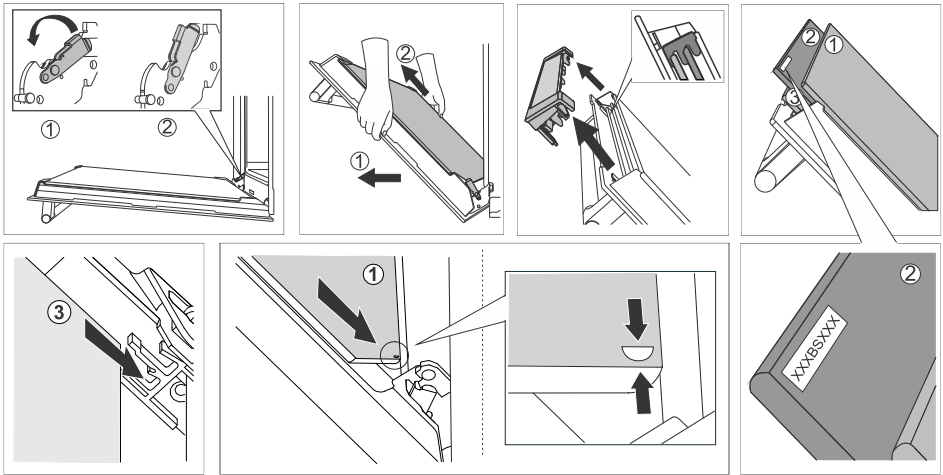

1.	When replacing the oven door, first open the door fully .
2.	Oven door is attached to the hinges with special supports that also include safety levers. Move the safety lever towards the door at an angle of 90°. Gradually close the door to a 45° angle; then lift the door and pull it out.
3.	In order to clean the door windows from the inside, first remove the glass from the appliance door. Follow steps 1 to 4 for the glass removal process, leaving the door in place and not removed from the oven.
4.	Remove the air guide. Hold it on the left- and right-hand side of the door with your hands and slightly pull it towards you to remove it.
5.	When removing the oven door windows, grip the top edge of the glass and remove it carefully. Repeat the same procedure for the second and, if necessary, third glass, depending on the oven model. Ensure that the process is carried out carefully and gently to prevent any damage to the windows or other parts of the oven.
6.	To replace the door glass, use the reverse order. Make sure that the glass is properly aligned and installed safely to ensure the correct operation of the oven.

In case the door does not open or close properly, make sure the hinges are installed properly.

WARNING!

Always rotate both safety levers towards the support when fitting or removing the appliance door. This is crucial to prevent possible damage, as the door hinge can close with considerable force.

Soft door closing and opening

Oven door is fitted with a system that dampens the closing force and allows for easy, quiet and gentle opening and closing of the door. A gentle push to an angle of 15° (relative to the open position of the door) is enough for the door to close softly and automatically.

WARNING!

If the force applied to close the door is too strong, the effect of the system is reduced and the safety mechanism effect is decreased.

Replacing the bulb

WARNING!

The oven has a built-in LED light, which can only be replaced by an authorised technician.

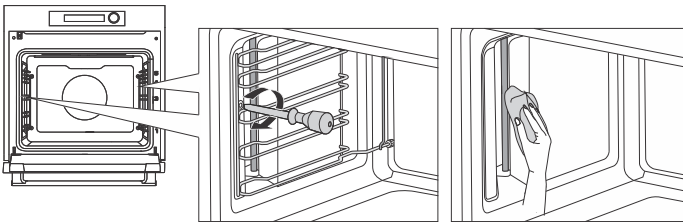

1. Remove the guide rails (see chapter *Removing wire and fixed pull-out (extendible) guides*).
2. For less stubborn dirt, cleaning with a damp cloth is sufficient.
In case of stubborn stains, the LED light can be cleaned with a dedicated oven cleaner.

Troubleshooting

During the warranty period, only a service center authorized by the manufacturer may carry out any repairs.

- Before making any repairs, make sure the appliance is disconnected from the power mains either by removing the fuse or by disconnecting the power plug from the wall outlet.
- Any unauthorized repairs of the appliance may result in electric shock and short circuit hazard; therefore, do not perform them. Leave such work to an expert or a service technician.
- In case of minor problems with appliance operation, check this manual to see if you can fix the problem yourself.
- If the appliance is not operating properly or at all due to inappropriate operation or handling, a visit from a service technician shall not be free of charge, even during the warranty period.
- Save the instructions for future reference and pass them on to any subsequent owners or users of the appliance.
- Following is some advice on rectifying some common problems.

Troubleshooting table

Problem/error	Cause
The main fuse in your home trips often.	Call a service technician.
The oven lighting does not work.	The process of changing the light bulb in the oven is described in the chapter Replacing the bulb.
Control unit is not responding, the screen is frozen.	Press and hold the On/Off button for 8 seconds until the screen is reset. Disconnect the appliance from the power mains for a few minutes (undo the fuse or switch off the main switch); then, reconnect the appliance and switch it on.
The display shows the error Err X. In case of a double-digit error code, the display will show Err XX.	There is an error in the electronic module operation. Disconnect the appliance from the power mains for a few minutes. If the error is still indicated, call a service technician.
The display will show SEoS when the food probe is not connected.	Clean the socket. Try to connect and disconnect the food probe several times in succession.
Steam accumulating on the display when opening the door.	Open the oven door completely, do not keep it somewhat closed.
Large amount of steam when cooking.	Certain foods contain a lot of water, so a large amount of steam is normal.
Meat probe appears on the screen, although it is not in use.	The cause of the error may be drops or dirt in the socket of the meat probe. We recommend inserting and removing the meat probe several times to clean the socket.
If the problems persist despite observing the above advice, call an authorized service technician. Repair or any warranty claim resulting from incorrect connection or use of the appliance shall not be covered by the warranty. In this case, the user will cover the cost of repair.	

Label – appliance information

A rating plate with basic information about the appliance is attached to the edge of the oven. Precise information on appliance type and model can also be found on the warranty sheet.

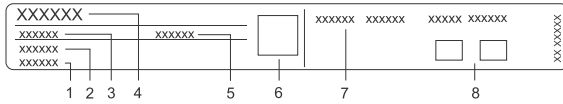

- | | |
|------------------|------------------------------|
| 1. Serial number | 5. ID/code |
| 2. Model | 6. QR code |
| 3. Type | 7. Technical information |
| 4. Brand | 8. Compliance labels/symbols |

Compliance information

Radio equipment type:	Built-in WiFi/BLE module
Wi-Fi	
Operating frequency range:	2412 ~ 2472 MHz
Maximum output power:	19.99 dBm EIRP
Maximum antenna gain:	3.26 dBi
Bluetooth	
Frequency range:	2402 ~ 2480 MHz
Carrier Output:	10.00 dBm
Emission type:	F1D

The company declares that the device with the function Connectlife complies with the essential requirements and other relevant provisions of Directive 2014/53/EU. The detailed Declaration of Conformity can be found at the web address <https://auid.connectlife.io> on the page of your device among the additional documents.



Our product packaging is made of environmentally friendly materials that can be recycled, disposed of, or destroyed without any hazard to the environment. To this end, packaging materials are labelled appropriately.

The symbol on the product or its packaging indicates that the product should not be treated as normal household waste. Take the product to an authorized collection centre for waste electric and electronic equipment processing.

Correct **disposal** of the product will help prevent any negative effects on the environment and health of people, which could occur in case of incorrect product removal. For detailed information on removal and processing of the product, please contact the relevant municipal body in charge of waste management, your waste disposal service, or the store where you bought the product.

We reserve the right to any changes and errors in the instructions for use.

Cooking test

EN60350-1: Only use equipment supplied by the manufacturer.

Always insert the baking tray all the way to the end position on the wire guide. Place pastry or cakes baked in moulds as shown in the image.

* Preheat the appliance until it reaches the set temperature. Do not use the rapid preheat mode.

** Preheat the appliance for 5 minutes. Do not use the rapid preheat mode.

*** Preheat the appliance for 10 minutes. Do not use the rapid preheat mode.

1) Turn after 2/3 of cooking time.





















BAKING							
Dish	Equipment	mould placement	 cm		 °C	 min	
shortbread – single rack	all-purpose baking tray		60	3	140-150**	25-35	—
			45	2	140**	30-45	—
shortbread – single rack	all-purpose baking tray		60	3	140-150	30-40	
			45	2	120-130**	40-55	
shortbread – two racks/levels	all-purpose baking tray		60	2,4	135***	40-50	
			45	1,3	140	40-50	
small cakes – single rack	all-purpose baking tray		60	3	160-170***	20-30	—
			45	2	150-160**	25-35	—
small cakes – single rack	all-purpose baking tray		60	3	155-165***	20-30	
			45	2	160-170***	25-35	
small cakes – two racks/levels	all-purpose baking tray		60	2,4	140-150	40-50	
			45	1,3	160-170**	40-50	
sponge cake	round metal mould, diameter 26 cm/wire rack		60	1	160***	25-35	—
			45	2	160***	25-35	—
sponge cake	round metal mould, diameter 26 cm/wire rack		60	3	170-180**	25-35	
			45	1	155-165	25-35	
apple pie	2 x round metal mould, diameter 20cm/wire rack		60	1	160-170***	70-90	—
			45	2	170-180***	70-90	—

Table continued from last page

BAKING							
apple pie	2 × round metal mould, diameter 20cm/wire rack		60	3	175	70-90	
			45	2	155-165	70-90	
BROILING							
toast	wire rack		60	5	max	5-15	
			45	4			
Burgers ¹⁾	wire rack + shallow baking sheet as drip tray		60	4	max	30-45	
			45	3			

 **ASKO**



942127-a12

CE