

## Operating and installation instructions Speed oven



It is **essential** to read these operating and installation instructions before installing and using the appliance. This prevents both personal injury and damage to the appliance.

# Contents



---

<b>Warning and safety instructions</b> .....	<b>6</b>
<b>Caring for the environment</b> .....	<b>16</b>
<b>Overview</b> .....	<b>17</b>
<b>Controls</b> .....	<b>18</b>
On/Off sensor.....	19
Proximity sensor.....	19
Sensor controls.....	20
Touch display.....	22
Symbols.....	23
<b>Operating principles</b> .....	<b>24</b>
Selecting a menu option.....	24
Scrolling through menus.....	24
Exiting a menu.....	24
Changing a value or setting.....	24
Changing a setting in a list.....	24
Entering numbers with the roller.....	24
Entering numbers using the numerical keypad.....	24
Changing the setting with a segment bar.....	24
Entering letters.....	25
Displaying the context menu.....	25
Moving entries.....	25
Displaying the pull-down menu.....	25
Displaying Help.....	25
Activating MobileStart.....	25
<b>Features</b> .....	<b>26</b>
Data plate.....	26
Items supplied.....	26
Accessories supplied and available to order.....	26
Safety features.....	29
PerfectClean treated surfaces.....	29
<b>Before using for the first time</b> .....	<b>30</b>
Miele@home.....	30
Standard settings.....	31
Heating up the oven for the first time.....	32
<b>Settings</b> .....	<b>33</b>
Settings overview.....	33
Opening the “Settings” menu.....	36
Language  .....	36
Time.....	36
Date.....	36
Lighting.....	37
Start screen.....	37
Display.....	37

Volume .....	37
Units .....	38
Quick MW .....	38
Popcorn.....	38
Booster .....	38
Recommended temperatures.....	39
Recommended power levels .....	39
Cooling fan run-on.....	39
Proximity sensor .....	40
Safety .....	40
Furniture front recognition .....	41
Miele@home .....	41
Performing Scan & Connect.....	42
Remote control .....	42
Activating MobileStart .....	42
SuperVision .....	42
RemoteUpdate .....	43
Software version.....	44
Legal information .....	44
Showroom programme.....	44
Factory default settings.....	44
Operating hours (total) .....	44
<b>Alarm + minute minder .....</b>	<b>45</b>
Using the Alarm function.....	45
Using the Minute minder function.....	46
<b>Main and sub-menus .....</b>	<b>47</b>
<b>Microwave operation .....</b>	<b>49</b>
How it works .....	49
Suitable crockery .....	49
Suitable containers.....	50
Unsuitable containers .....	52
Testing dishes for their suitability.....	52
Cover .....	53
<b>Operation .....</b>	<b>54</b>
Changing values and settings for a cooking programme .....	54
Changing the temperature and core temperature .....	55
Changing the microwave power level .....	55
Setting cooking durations.....	55
Changing the set cooking durations .....	56
Deleting the set cooking durations .....	56
Interrupting a cooking programme in the Microwave function .....	56
Cancelling cooking .....	56

# Contents

---

Pre-heating the oven.....	56
Booster.....	57
Pre-heat.....	57
Crisp function.....	58
Changing the function .....	58
<b>Quick MW and Popcorn .....</b>	<b>59</b>
<b>Automatic programmes .....</b>	<b>60</b>
Categories .....	60
Using Automatic programmes.....	60
Usage notes .....	60
Search .....	61
<b>Special applications .....</b>	<b>62</b>
Defrost .....	62
Drying.....	65
Reheat.....	66
Heat crockery.....	69
Prove yeast dough.....	69
Keeping warm .....	69
Low temp. cooking.....	70
Cooking.....	72
Bottling.....	74
Frozen food/Ready meals.....	76
<b>MyMiele .....</b>	<b>77</b>
<b>User programmes .....</b>	<b>78</b>
<b>Baking.....</b>	<b>81</b>
Tips on baking.....	81
Notes on the cooking charts .....	81
Notes on the oven functions .....	81
<b>Roasting .....</b>	<b>83</b>
Tips for roasting.....	83
Notes on the cooking charts .....	83
Notes on the oven functions .....	84
Food probe .....	85
<b>Grilling .....</b>	<b>87</b>
Tips for grilling.....	87
Notes on the cooking charts .....	87
Notes on the oven functions .....	88
Fan Grill  .....	89
Grill  .....	90
<b>Cleaning and care .....</b>	<b>91</b>
Unsuitable cleaning agents.....	91
Removing normal soiling .....	92
Removing stubborn soiling.....	93

---

Lowering the top heat/grill element.....	94
<b>Problem solving guide</b> .....	<b>95</b>
<b>Service</b> .....	<b>101</b>
Contact in case of fault.....	101
Warranty .....	101
<b>Installation</b> .....	<b>102</b>
Building-in dimensions .....	102
Installation in a tall or base unit.....	102
Side view.....	103
Connections and ventilation .....	104
Installing the oven .....	105
Electrical connection .....	106
<b>Cooking charts</b> .....	<b>107</b>
Creamed mixture.....	107
Rubbed in mixture .....	108
Yeast dough.....	109
Quark dough.....	109
Sponge mixture.....	110
Choux pastry, puff pastry, meringue .....	110
Savoury snacks .....	111
Beef .....	112
Veal .....	113
Pork.....	114
Lamb, game .....	115
Poultry, fish.....	116
<b>Technical data</b> .....	<b>117</b>
Copyright and licences for the communication module.....	117
Copyright and licences .....	118

## Warning and safety instructions

---

► For the sake of simplicity, the speed oven will subsequently be referred to as the “oven”.

This oven complies with all current local and national safety requirements. However, inappropriate use can lead to personal injury and damage to property.

Read the operating and installation instructions carefully before using the oven for the first time. They contain important information on safety, installation, use and maintenance of the appliance. This prevents both personal injury and damage to the oven.

In accordance with standard IEC 60335-1, Miele expressly and strongly advises that you read and follow the instructions in “Installation”, as well as in the “Warning and Safety instructions”.

Miele cannot be held liable for injury or damage caused by non-compliance with these instructions.

Keep these instructions in a safe place and pass them on to any future owner.

### Correct application

► This oven is designed for domestic use and for use in similar environments by guests in hotel or motel rooms, bed & breakfasts and other typical living quarters. This does not include common/shared facilities or commercial facilities within hotels, motels or bed & breakfasts.

► The oven is not suitable for outdoor use.

► It is intended only to cook, bake, roast, grill, defrost, bottle and reheat food. Any other use is not permitted.

► Fire hazard due to flammable materials.

If flammable items were dried in the microwave oven, the moisture in the items would evaporate. This could cause the materials to dry out and possibly self-ignite.

Never use the oven to store or dry items which could ignite easily.

► This oven is not intended for use by persons (including children) with reduced physical, sensory or mental capabilities, or lack of experience and knowledge, unless they are supervised whilst using it. They may only use the oven unsupervised if they have been shown how to use it in a safe manner. They must be able to recognise and understand the dangers of misuse.

▶ The oven compartment is equipped with special lamps to cope with particular conditions (e.g. temperature, moisture, chemical resistance, abrasion resistance and vibration). These special lamps must only be used for the purpose for which they are intended. They are not suitable for room lighting. Replacement lamps may only be fitted by a Miele authorised technician or by Miele.

### Safety with children

▶ Activate the system lock to ensure that children cannot switch on the oven inadvertently.

▶ Young children must not be allowed to use this appliance.

▶ Older children may only use the oven if its operation has been clearly explained to them and they are able to use it safely. They must be able to understand and recognise the possible dangers caused by incorrect operation.

▶ Cleaning work may only be carried out by older children under the supervision of an adult.

▶ Children should be supervised in the vicinity of the oven. Never allow children to play with the oven.

▶ Risk of suffocation from packaging material. Whilst playing, children may become entangled in packaging material (such as plastic wrapping) or pull it over their head with the risk of suffocation. Keep packaging material away from children.

▶ Risk of injury caused by hot surfaces. Children's skin is far more sensitive to high temperatures than that of adults. External parts of the oven such as the door glass, control panel and the vent become quite hot.

Do not let children touch the oven when it is in operation.

▶ Risk of injury from the open door. The oven door can support a maximum weight of 8 kg. Children could injure themselves on an open door.

Do not let children sit on the open door, lean against it or swing on it.

▶ If you touch the  sensor, the door will fully open automatically. In doing so, it can knock against small children or animals, for example. If the buzzers are switched on, a buzzer will sound on the oven when you open the door remotely using a voice-based service. Ensure that no person or object is located within the opening range of the door when it is opened. Make sure that you keep the buzzers switched on.

# Warning and safety instructions

---

## Technical safety

- ▶ Unauthorised installation, maintenance and repairs (including removal of any cover) can cause considerable danger for the user. Installation, maintenance and repairs must only be carried out by a Miele authorised technician.
- ▶ Damage to the oven can compromise your safety. Check the oven for visible signs of damage. Do not use a damaged oven.
- ▶ Temporary or permanent operation with a self-sufficient or non-mains synchronous energy supply system (e.g. isolated networks, back-up systems) is possible. A requirement for the operation is that the energy supply system complies with all current local and national requirements that apply to stand-alone, solar and/or battery systems. The protective measures provided in the installation and in this Miele product must also be assured in their function and operation in isolated operation or in non-mains synchronous operation, or replaced with equivalent measures in the installation.
- ▶ Operating a damaged oven can result in microwave leakage and present a hazard to the user. Do not use the oven if:
  - the door is warped.
  - the door hinges are loose.
  - holes or cracks are visible in the casing, the door or the oven compartment walls.
- ▶ The electrical safety of this appliance can only be guaranteed when continuity is complete between it and an effective earthing system. It is essential that this basic safety requirement is present and tested regularly. If in doubt, the electrical installation should be checked by a qualified electrician.
- ▶ The connection data (voltage and frequency) on the data plate of the oven must match the mains electricity supply in order to avoid the risk of damage to the oven. Compare this before connecting the appliance to the mains electricity. If in any doubt, consult a qualified electrician.
- ▶ Multi-socket adapters and extension leads do not guarantee the required safety of the appliance. Do not use these to connect the oven to the mains electricity supply.
- ▶ For safety reasons, the oven may only be used when it has been fully installed.

## Warning and safety instructions



---

- ▶ This oven must not be installed and operated in mobile installations (e.g. on a ship).
- ▶ Risk of injury due to electric shock. Any contact with live connections or tampering with the electrical or mechanical components of the oven will endanger your safety and may lead to appliance malfunctions.  
Do not open the oven housing under any circumstances.
- ▶ The manufacturer's warranty will be invalidated if the appliance is not repaired by a Miele approved service technician.
- ▶ Miele can only guarantee the safety of the appliance when original Miele spare parts are used. Faulty components must only be replaced by original spare parts.
- ▶ If the oven is delivered without a mains connection cable, a special cable must be installed by a suitably qualified and competent person (see “Installation - Electrical connection”).
- ▶ If the mains connection cable is damaged, it must be replaced with a special connection cable by a suitably qualified and competent person in order to avoid a hazard (see “Installation - Electrical connection”).
- ▶ During installation, maintenance and repair work, the oven must be completely disconnected from the mains electricity supply. To ensure this:
  - Switch off the mains circuit breaker, or
  - switch off at the wall socket and withdraw the plug. To do this, pull the plug and not the mains connection cable.
- ▶ The oven requires a sufficient supply of cool air for efficient operation. Make sure that the supply of cool air is not hindered in any way (e.g. by heat insulation strips fitted in the housing unit). Furthermore, the required supply of cool air must not be excessively heated by other heat sources (e.g. solid fuel stoves).
- ▶ If the oven is built in behind a furniture front (e.g. a door), do not close the furniture door while the oven is in use. Heat and moisture can build up behind the closed furniture door. This can result in damage to the oven, housing unit and floor. Leave the furniture door open until the oven has cooled down completely.

# Warning and safety instructions



---

## Correct use

- ▶ Risk of injury caused by hot surfaces. The oven gets hot during operation. You could burn yourself on the heating elements, oven compartment, accessories or food.  
Wear oven gloves when placing food in the oven or removing it, and when adjusting oven shelves etc. in a hot oven.
- ▶ To avoid fuelling any flames, do not open the oven door if smoke occurs inside the appliance. Interrupt the process by switching the appliance off and disconnect it from the mains electricity supply. Do not open the door until the smoke has dispersed.
- ▶ Due to the high temperatures radiated, objects left near the oven could catch fire. Do not use the oven to heat up the room.
- ▶ Oils and fats can ignite if allowed to overheat. Never leave the oven unattended when cooking with oil or fats. Never attempt to put out oil or fat fires with water. Switch the oven off and extinguish the flames by leaving the door closed.
- ▶ Grilling food for excessively long cooking durations can cause it to dry out with the risk of catching fire. Do not exceed the recommended cooking durations.
- ▶ Please be aware that durations when using microwave power are often considerably shorter when cooking, reheating and defrosting than when using functions without microwave power. Excessively long cooking durations can lead to food drying out and burning, or could even cause it to catch fire.  
Do not exceed recommended grilling times when using Grill functions. Do not use the Microwave  function to dry flowers or herbs or to crisp up bread or rolls. Never use a Grill function to dry flowers, herbs or the like. Use the Fan Plus  or Conventional Heat  function and always ensure this type of procedure is supervised.
- ▶ If using alcohol in your recipes, please be aware that high temperatures can cause the alcohol to evaporate. The vapour can catch fire on hot heating elements.
- ▶ When using residual heat to keep food warm, corrosion from high air humidity and condensation can occur in the oven. This can also cause damage to the control panel, worktop and surrounding kitchen furniture. Keep the oven on and select the lowest temperature available for the selected function. The cooling fan will then continue to run and dissipate the moisture.

## Warning and safety instructions

---

- ▶ Food which is stored in the oven compartment or left in it to be kept warm can dry out and the moisture released can lead to corrosion damage in the oven. Always cover food that is left in the oven to keep warm.
- ▶ A build-up of heat can cause damage to the oven. Never line the floor of the oven compartment with aluminium foil or oven liners. If you wish to place crockery on the floor of the oven compartment during cooking, or place crockery on the floor of the oven compartment to heat it up, you can do so, but only with the Fan Plus  or Eco Fan Heat  function without the Booster function.
- ▶ The oven compartment floor can become damaged by items being pushed around on it. When placing pots, pans or crockery on the oven compartment floor, ensure that you avoid pushing them around.
- ▶ Danger of injury caused by steam. Pouring a cold liquid onto a hot surface creates steam, which can cause severe scalding. The sudden temperature change can also cause damage to hot surfaces. Never pour cold liquids directly onto hot surfaces.
- ▶ The oven is not suitable for cleaning or disinfecting items. Items can get extremely hot. There is a risk of burning when items are removed from the oven.
- ▶ It is important that the temperature in the food being cooked is evenly distributed and sufficiently high. This can be achieved by stirring or turning the food, and observing a sufficiently long standing time (see charts), which should be added to the time needed for reheating, defrosting or cooking. During the standing time, the temperature is distributed evenly in the food.
- ▶ When heating food, and in particular liquids, using the Microwave  function, the boiling point may be reached without the production of typical bubbles. Liquids do not boil evenly throughout. This boiling delay can result in the liquid boiling over explosively. Take care when taking the container out of the oven, as the hot liquid can cause severe scalding. Under certain circumstances, the pressure can be so high that the door opens automatically. Stir liquids well before reheating or cooking. After heating, wait at least 20 seconds before removing the container from the oven. In addition, a glass rod or similar item, if available, can be placed in the container during heating.

## Warning and safety instructions

---

▶ Risk of injury caused by hot food. When heating food up, the heat is created directly in the food itself. For this reason, the crockery will remain cooler than the food (except when using ovenproof stoneware). The crockery is only warmed by the heat of the food. Before serving, always check the temperature of the actual food itself after taking it out of the oven. The temperature of the container is not an indication of the temperature of the food or liquid in it. **This is particularly important when heating food for babies, children, and the elderly or infirm.** After reheating food, especially food for babies and small children, stir the food or shake the container and check that the temperature does not pose any danger of burning. Double check after it has been left to stand.

▶ Risk of injury from increased pressure in sealed containers or bottles. Pressure can build up when reheating food or drinks in sealed containers, jars or bottles, which can cause them to explode. Never cook or reheat food or liquids in sealed containers or bottles. Open containers beforehand. In the case of baby bottles, the screw top and teat must be removed.

▶ If you cook eggs without their shells, the yolks could explode due to the resulting pressure.

Prick the yolk several times before cooking to avoid this.

▶ Eggs heated in their shells can burst, even after they have been taken out of the oven compartment.

Eggs can only be cooked in their shells in a specially designed egg-boiling device. Do not reheat hard boiled eggs using the Microwave  function.

▶ Food with a thick skin or peel, such as tomatoes, sausage, potatoes and eggplants can burst when heated or cooked. Pierce or score the skin of these types of food several times to allow steam to escape.

▶ Do not use a thermometer containing mercury or liquid as these are not suitable for use with very high temperatures and break very easily.

Only use the Miele food probe supplied with the appliance to measure the temperature of the food.

▶ Cushions or pads filled with cherry kernels, gel, etc., such as those used in aromatherapy, can ignite when heated even after they have been removed from the oven.

Do not heat these up in the oven.

## Warning and safety instructions

---

▶ Crockery and lids with hollow handles or knobs can collect moisture in the hollow spaces. When the moisture evaporates, pressure can build up and the item can explode. If the hollow recess is sufficiently ventilated, the item can be used.

Do not use crockery with hollow knobs or handles when using the Microwave  function.

▶ Non-microwave safe plastic dishes can suffer damage or damage the oven if used with the Microwave  function and or functions that use microwaves.

Do not use any containers or cutlery made from or containing metal, aluminium foil, lead crystal glassware, temperature-sensitive plastics, wooden utensils or cutlery, metal clips or plastic or paper covered wire ties. Do not use bowls with milled rims, or plastic pots with the foil lid only partially removed (see "Microwave operation - Suitable containers for microwave use").

▶ Plastic dishes that are not suitable for use in an oven will melt and may ignite at high temperatures and damage the oven.

Use only plastic dishes that are suitable for use in an oven when using functions that do not use microwave power. Follow the manufacturer's instructions.



▶ Fire hazard due to containers made of flammable materials. Plastic disposable containers must meet the requirements specified for crockery in "Microwave operation - Suitable containers for microwave use".

Do not leave the oven unattended when heating or cooking food in disposable containers made of plastic, paper or other inflammable materials.

▶ Heat-retaining bags usually contain a thin layer of aluminium foil that reflects microwave radiation. Because of this, the paper surrounding the aluminium foil can become so hot that it combusts. Do not use heat-retaining packaging, such as bags for grilled chicken, for warming food with functions that use microwave power.

▶ If the oven is used without food or the food is loaded incorrectly when using the Microwave  function or functions that use microwave power, the oven can become damaged.

**Always** use the glass tray with the Microwave  function, even if you use it as a container for smaller dishes.

Do not use any functions that use microwave power to pre-heat crockery or to dry herbs. Instead, use the Fan Plus  or Conventional Heat  function.

## Warning and safety instructions

---

- ▶ Preserving and heating food in sealed tins will result in an increase in pressure, which can cause them to explode. Do not use tins for preserving or heating food.
- ▶ Risk of injury from the open door. You could bang into the open door or trip over it. Avoid leaving the door open unnecessarily.
- ▶ The door can support a maximum load of 8 kg. Do not lean or sit on an open door, or place heavy items on it. Make sure that nothing gets trapped between the door and the oven compartment. This could damage the oven.

### **The following applies for stainless steel surfaces:**

- ▶ The coated stainless steel surface can be damaged by adhesives and will lose its dirt-repelling properties. Do not use sticky notes, adhesive tape or other types of adhesive on the stainless steel surface.
- ▶ Magnets can cause scratches. Do not use the stainless steel surface as a magnetic notice board.

## Cleaning and care

- ▶ Risk of injury due to electric shock. The steam from a steam cleaning appliance could reach electrical components and cause a short circuit. Never use a steam cleaner for cleaning.
- ▶ Scratches on the door glass can cause the glass to break. Do not use abrasive cleaners, hard sponges, brushes or sharp metal tools to clean the door glass.
- ▶ Try to avoid the interior walls being splashed with food containing salt. If this does happen, wipe it away thoroughly to avoid corrosion to stainless steel surfaces inside the oven compartment.
- ▶ In warm, moist environments, there is a higher probability of vermin infestations (e.g. cockroaches). Ensure the oven and the area surrounding it are always kept clean.  
Damage caused by vermin is not covered by the warranty.

### Accessories

- ▶ Only use original Miele accessories. If other parts are used, warranty, performance and product liability claims will be invalidated.
- ▶ Miele will guarantee to supply functional spare parts for a minimum of 10 years and up to 15 years following the discontinuation of your oven.
- ▶ Only use the Miele food probe supplied with the appliance. If it is faulty, it must be replaced with a new original Miele food probe.
- ▶ The plastic on the food probe can melt at very high temperatures. Do not use the food probe when using the Grill functions. Do not store the food probe in the oven compartment when it is not being used.

# Caring for the environment

---

## Disposal of the packing material

The transport and protective packaging has been selected from materials which are environmentally friendly for disposal, and can normally be recycled.

Recycling the packaging reduces the use of raw materials in the manufacturing process and also reduces the amount of waste in landfill sites.

Ensure that any plastic wrappings, bags etc. are disposed of safely and kept out of the reach of babies and young children. Danger of suffocation.

## Disposing of your old appliance

Electrical and electronic appliances often contain valuable materials. They also contain specific materials, compounds and components, which were essential for their correct function and safety. These could be hazardous to human health and to the environment if disposed of with your domestic waste or if handled incorrectly. Please do not, therefore, dispose of your old appliance with your household waste.



Please dispose of it at your local community waste collection / recycling centre for electrical and electronic appliances. You are also responsible for deleting any personal data that may be stored on the appliance prior to disposal. Please ensure that your old appliance poses no risk to children while being stored prior to disposal.

## Oven

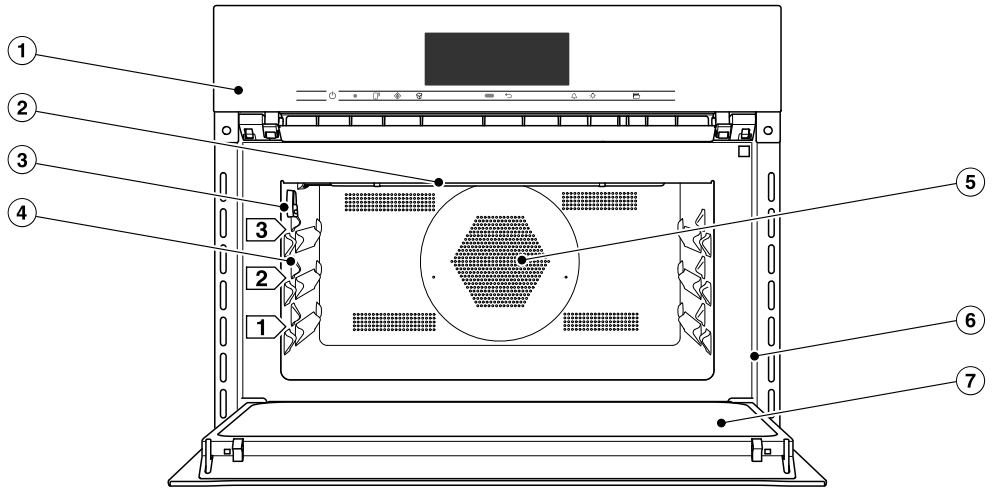

- ① Control panel
- ② Top heat/grill element
- ③ Connection socket for the food probe
- ④ 3 Shelf levels for the glass tray and rack
- ⑤ Air inlet for the fan with ring heating element behind it
- ⑥ Front frame with data plate
- ⑦ Door

# Controls

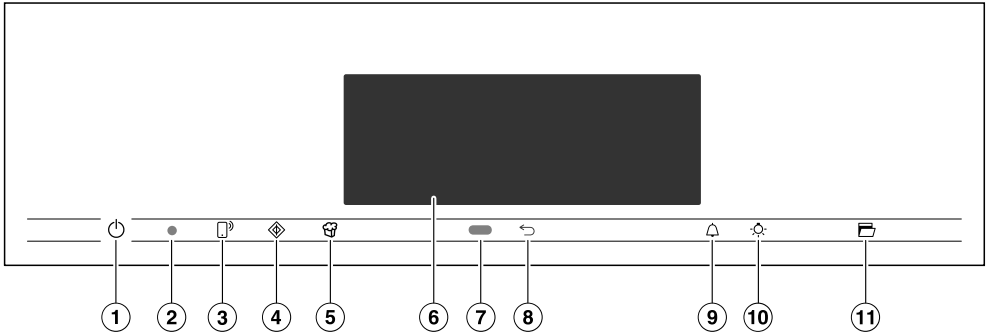

- ① Recessed On/Off ⏻ sensor  
For switching the oven on and off
- ② Optical interface  
(for Miele service technicians only)
- ③ 📱 sensor  
For controlling the oven via your mobile device
- ④ ⬠ sensor  
For starting the Quick MW function
- ⑤ 🍿 sensor  
For starting the Popcorn function
- ⑥ Touch display  
For displaying information and for operation
- ⑦ Proximity sensor  
For switching on the oven interior lighting and the display when approached, and to dismiss the buzzer when movement is detected
- ⑧ ⬅️ sensor  
To go back a step
- ⑨ 🔔 sensor  
For setting the minute minder or alarms
- ⑩ 💡 sensor  
For switching the oven interior lighting on and off
- ⑪ 🚪 sensor  
For opening the door

### **On/Off sensor**

The On/Off  sensor is recessed and reacts to touch.

Use this sensor to switch the oven on and off.

### **Proximity sensor**

The proximity sensor is located under the touch display next to the  sensor. The proximity sensor detects when you approach the touch display, e.g. with your hand or body.





If you have activated the corresponding settings, you can switch on the oven interior lighting, switch on the oven or acknowledge the buzzers (see “Settings – Proximity sensor”).

# Controls



## Sensor controls

The sensors react to touch. Every touch on the sensors is confirmed by a keypad tone. This keypad tone can be switched off by selecting the **Volume | Keypad tone | Off** setting.

If you want the sensors to respond even when the oven is switched off, select the **Display | QuickTouch | On** setting.

Sensor	Function
	<p>If you want to control the oven from your mobile device, you must have the Miele@home system, switch on the <b>Remote control</b> setting and touch this sensor. The sensor then lights up and the <b>MobileStart</b> function is available.</p> <p>As long as this sensor is illuminated, you can control the oven via your mobile device (see “Settings – Miele@home”).</p>
	<p>Use this sensor to start the <b>Quick MW</b> function. The cooking programme runs with the maximum power level (1000 W) and a cooking duration of 1 minute (see “Quick MW”). Touching the sensor control repeatedly increases the cooking duration in increments.</p> <p>This function can only be used when no other cooking programmes are in use.</p>
	<p>Use this sensor to start the <b>Popcorn</b> function. The cooking programme runs with 850 W and a cooking duration of 2:50 minutes (see “Popcorn”).</p> <p>This function can only be used when no other cooking programmes are in use.</p>
	<p>Depending on which menu you are in, this will take you back a level or back to the main menu.</p>

## Controls

Sensor	Function
	If a menu appears in the display or if a cooking programme is in progress, you can use this sensor to set a minute minder (e.g. when boiling eggs on the cooktop) or an alarm (a specific time) at any point (see “Alarm + minute minder”).
	Select this sensor to switch the oven interior lighting on and off. Depending on the setting selected, the oven interior lighting switches off after 15 seconds or remains constantly switched on or off.
	Use this sensor to open the door automatically. To close it, press against the door frame with your hand or with a suitable pot holder or oven glove until the door shuts.

# Controls

## Touch display

The sensitive surface of the touch display can be scratched by pointed or sharp objects, e.g. pens.

Only touch the display with your fingers.

Make sure that water cannot get behind the touch display.

The touch display is split into multiple areas.

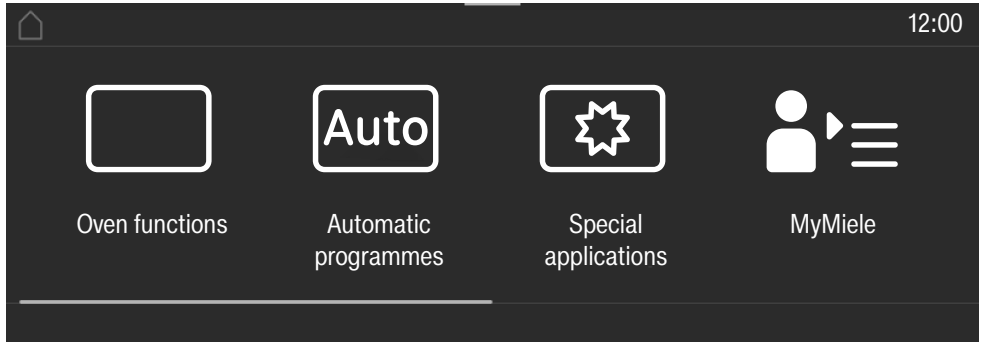

The menu path appears on the left of the **header**. The individual menu options are separated by a vertical line. ... I indicates that there are more options available, which are not visible because there is not enough space in the display.

If you touch a menu name in the header, the display will switch to that menu. To switch to the start screen, touch .

The time of day is shown on the right of the header. You can set the time of day by touching the display.

Additional symbols may also appear, e.g. SuperVision .

At the top of the header there is an orange line where you can drag down the pull-down menu. This allows you to switch settings on or off during a cooking programme.

The current menu and menu options are shown in the **centre**. You can scroll to the right or left by swiping your finger across the display to the right or left. Touch a menu option to select it (see “Operating principles”).

The operation fields that appear in the **footer** vary according to the menu that is selected; e.g. Timer, Save or OK.

## Symbols

The following symbols may appear in the display:

Symbol	Meaning
	This symbol indicates that there is additional information and advice about using the appliance. Select <i>OK</i> to confirm the information.
	This indicates that there are more options available, which are not visible because there is not enough space in the display.
	Alarm
	Minute minder
	Some settings, e.g. display brightness and signal tone volume, are selected using a segment bar.
	The system lock or sensor lock is on (see “Settings – Safety”). The controls are locked.
	Core temperature when using the food probe
	Remote control (only appears if you are in the Miele@home system and have selected the Remote control   On setting).
	SuperVision (only appears if you are in the Miele@home system and have selected the SuperVision   SuperVision display   On setting)

# Operating principles

---

You operate the oven via the touch display by touching the desired menu option.

Each time you touch a possible option the relevant characters (word and/or symbol) light up **orange**.

Fields for confirming an operating step are highlighted in **green** (e.g. *OK*).

## Selecting a menu option

- Touch the desired field or value in the touch display.

## Scrolling through menus

You can scroll left or right.

- Swipe across the screen. To do this, place your finger on the touch display and swipe it in the direction you want.

The bar at the bottom shows you where you are in the current menu.

## Exiting a menu

- Touch the ↩ sensor or touch the ... I symbol in the menu path.
- Touch the 🏠 symbol to switch to the status display.

Entries made before this which have not been confirmed with *OK* will not be saved.

## Changing a value or setting

### Changing a setting in a list

The current setting is highlighted in orange.

- Touch the desired setting.

The setting is now saved. This will take you back to the previous menu.

### Entering numbers with the roller

- Swipe the roller up or down until the value you want is displayed in the centre.
- Confirm with *OK*.

The changed number is now saved.

### Entering numbers using the numerical keypad

- Tap on the value that is in the middle of the numerical keypad.

The numerical keypad will appear.

- Touch the required numbers.

As soon as you enter a valid value, *OK* turns green.

Use the arrow to delete the last entered number.

- Confirm with *OK*.

The changed number is now saved.

### Changing the setting with a segment bar

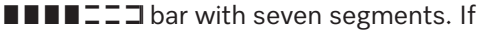
Some settings are represented by a  bar with seven segments. If all of the segments are illuminated, the maximum value is selected.

If none of the segments is illuminated or if only one is, the minimum value is selected or the setting is switched off altogether (e.g. buzzers).

- Touch the corresponding segment on the segment bar to change the setting.
- Select On or Off to switch the setting on or off.
- Confirm your selection with *OK*.

The setting is now saved. This will take you back to the previous menu.

## Entering letters

Letters are entered using a display keyboard. It is best to select short, memorable names.

- Touch the letters or characters you want.

**Useful tip:** You can add a line break for longer programme names using the ↵ symbol.

- Touch **Save**.

The name is now saved.

## Displaying the context menu

In some menus you can display a context menu, e.g. to rename User programmes or to move entries under MyMiele.

- For example, touch a User programme and keep your finger on it until the context menu opens.
- Touch the touch display outside of the menu window to close the context menu.

## Moving entries

You can change the order of User programmes or entries under MyMiele.

- For example, touch a User programme and keep your finger on it until the context menu opens.
- Select **Move**.
- Keep your finger on the highlighted field and drag it to the desired location.

## Displaying the pull-down menu

During a cooking programme, you can switch settings such as **Booster** or **Pre-heat** and the  **Wi-Fi** function on or off.

- Use the orange line under the header to drag the pull-down menu down.
- Select the setting you want to change. Active settings are highlighted in orange. Depending on the selected colour scheme, inactive settings are highlighted either in black or white (see “Settings – Display”).
- To close the pull-down menu, drag it back up to the top or touch an area of the display located outside of the menu window.

## Displaying Help

Context-sensitive help is available for certain functions. **Help** appears on the bottom line.

- Touch **Help** to display information in text and pictures.
- Touch **Close** to return to the previous menu.

## Activating MobileStart

- Select the  sensor to activate MobileStart.

The  sensor lights up. You can operate your oven remotely with the Miele App.

Directly operating the oven takes priority over operating it via the remote control function on the App.

You can use MobileStart as long as the  sensor is lit up.

## Features

A list of the models described in these operating and installation instructions can be found on the back page.

### Data plate

The data plate located on the front frame of the oven is visible when the door is open.

The data plate states the model number, the serial number as well as connection data (voltage, frequency and maximum rated load).

Have this information available if you need to contact Miele so that any issues can be rectified as quickly as possible.

### Items supplied

- The operating and installation instructions for using the oven and microwave functions
- A cookbook with recipes for the Automatic programmes and other functions
- Food probe
- Opener
- Screws for fixing the oven to the housing unit
- Various accessories

### Accessories supplied and available to order

This oven is supplied with two glass trays, a rack and a food probe.

All accessories and cleaning and care products listed in these instructions are designed for Miele ovens.

These are available to order via the Miele online shop or directly from Miele (see the end of this booklet for contact details).

When ordering, please quote the model number of your oven and the reference number of the accessories required.

### Glass tray

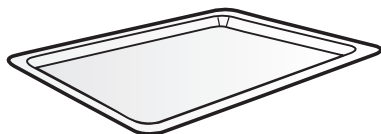

The glass tray is suitable for use with all cooking functions.

The glass tray can be damaged by large temperature fluctuations. Do not place the hot glass tray on a cold surface, such as a tiled or granite worktop. Use a suitable mat or pot rest.

- **Always** use the glass tray with the Microwave  function, even if you use it as a container for smaller dishes.
- The maximum load for the glass tray is 8 kg.

The glass tray has an anti-tip safety notch which prevents it being pulled right out when it only needs to be pulled out partially.

When pushing the glass tray back in, always ensure that the safety notch is at the **back** of the oven (see illustration).

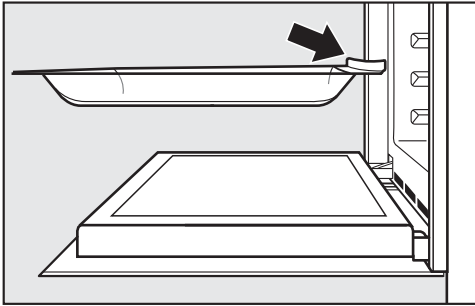

- To remove the glass tray, lift it upwards slightly at the front when the safety notch connects with the sides of the oven.

## Rack with anti-tip safety notches

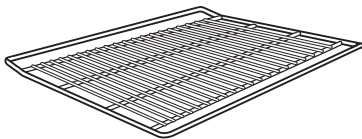

The rack is **not** suitable for use with the Microwave  function. You can use the rack for all other functions which use or do not use microwave power.

 Risk of injury caused by hot surfaces.

The rack gets hot during cooking programmes. Wear oven gloves when placing food in the oven or removing it, and when adjusting oven shelves etc. in a hot oven.

The oven and rack can be damaged by the possible creation of sparks. Do not use the rack for cooking programmes with the Microwave  function.

Do not place the rack on the oven floor. Place it on one of the shelf levels.

## Using the rack

The rack has anti-tip safety notches which prevent it being pulled right out when it only needs to be pulled out partially.

If you insert the rack the wrong way round, the anti-tip safety mechanism is not guaranteed.

When pushing the rack back in, always ensure that the safety notches are at the **back** of the oven.

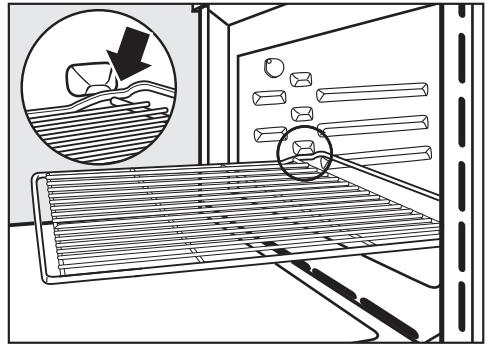

- To remove the rack, lift it upwards slightly at the front when the safety notches connect with the sides of the oven.

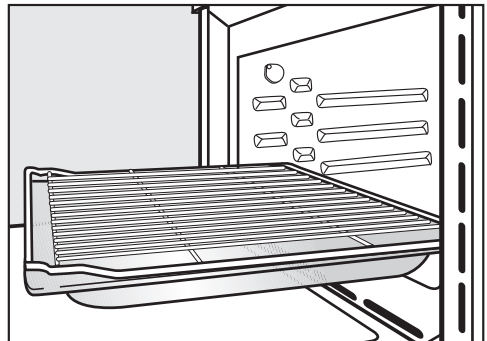

- We recommend using the rack together with the glass tray when cooking items on the rack which

## Features





might drip.

Only in this case should the safety notches be at the front.

- The maximum load for the rack is 8 kg.

### Round baking trays

The round baking trays can suffer damage when subjected to microwaves.

Do not use the round baking trays with the Microwave , MW + Auto Roast , MW + Fan Plus , MW + Grill  or MW + Fan Grill  functions.



The **solid round baking tray HBF 27-1** is suitable for cooking pizzas, flat cakes made with yeast or whisked mixtures, sweet and savoury tarts, baked desserts, flat bread, and can also be used for frozen cakes and pizzas.

The **perforated round baking and AirFry tray HBFP 27-1** can be used for the same purposes as the **perforated Gourmet baking and AirFry tray HBBL 71**.

The surface of both baking trays has been treated with PerfectClean enamel.

- Insert the rack and place the round baking tray on the rack.

### Baking stone HBS 70



The baking stone is ideal for items which need a well baked base such as pizza, quiche, bread, bread rolls and

savoury snacks.

The baking stone is made from heat-retaining fireclay and is glazed. A paddle made of untreated wood is supplied with the baking stone for placing food on it and taking it off.

- Slide the rack in and place the baking stone on it.

### Food probe

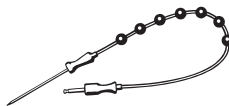

Using the food probe enables the temperature during the cooking process to be monitored simply and accurately (see "Roasting - Food probe").

### HUB Gourmet oven dishes HBD Gourmet oven dish lids

Gourmet oven dishes and their lids can suffer damage when subjected to microwaves. Metal reflects the microwaves which can create sparks and the microwaves are not absorbed by the metal.

Only use the oven dishes and their lids for cooking programmes with functions which **do not use** microwave power.

Insert the rack in shelf level 1 and place the Gourmet oven dish on the rack.

The surface of the Gourmet oven dishes has a non-stick coating and is suitable for induction cooktops.

Gourmet oven dishes are available in different depths. The width and the height are the same.

Suitable lids are available separately. Please quote the model number when ordering.

**Depth: 22 cm**

HUB 62-22

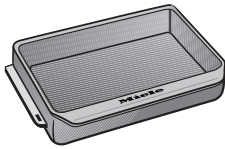

HBD 60-22

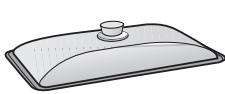

**Depth: 35 cm\***

HUB 62-35

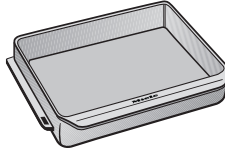

HBD 60-35

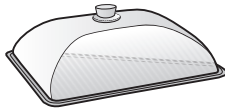

\* The oven dish cannot be used in conjunction with its lid in ovens with three shelf levels because the total height of these two items exceeds the height of the cavity.

## Accessories for cleaning and care

- Opener  
The opener can be used to lever the door open during a power cut. To do so, push the opener at an angle into the gap on the outside edge of the door at the top between the control panel and the door.
- Miele all purpose microfibre cloth
- Miele oven cleaner

## Safety features

- **System lock**   
(see “Settings – Safety”)
- **Sensor lock**  
(see “Settings – Safety”)
- **Cooling fan**  
(see “Settings – Cooling fan run-on”)
- **Safety switch-off**  
A function which does not use microwave power can be started without selecting a cooking duration. To prevent continuous use and avoid

the risk of fire, the oven will switch itself off automatically after a certain time after the last operation depending on the function and temperature selected.

## PerfectClean treated surfaces

Surfaces treated with PerfectClean enamel are characterised by their exceptional non-stick properties and ease of cleaning.

Food can be easily removed from these surfaces. Soiling from baking and roasting can be easily removed from these surfaces.

Food can be sliced or cut up on PerfectClean surfaces.

However, do not use ceramic knives as these will scratch the PerfectClean surface.

Surfaces treated with PerfectClean enamel can be cleaned as you would clean glass. Read the instructions in “Cleaning and care” so that the benefits of the non-stick properties and easy cleaning are retained.

PerfectClean treated surfaces:

- Oven compartment
- Rack
- Round baking and AirFry tray, perforated
- Round baking tray

# Before using for the first time

---

## Miele@home

Your oven is equipped with an integrated Wi-Fi module.

In order to use it, you need:

- a Wi-Fi network
- the Miele App
- a Miele user account. The user account can be created via the Miele App.

The Miele App will guide you as you connect your oven to your home Wi-Fi network.

Once your oven is connected to your Wi-Fi network, you can use the App for a number of actions, including the following:

- Call up information on the operating status of your oven
- Retrieve information on cooking processes that are in progress
- End cooking programmes that are in progress

Connecting your oven to your Wi-Fi network will increase energy consumption, even when the oven is switched off.

Make sure that the signal of your Wi-Fi network is sufficiently strong in the place where your oven is installed.

## Availability of the Wi-Fi connection

The Wi-Fi connection shares a frequency range with other appliances (including microwave ovens and remote control toys). This may result in sporadic or even complete connection failures. Therefore, a constant availability of featured functions cannot be guaranteed.

## Miele@home availability

The ability to use the Miele App depends on the availability of the Miele@home service in your country.

The Miele@home service is not available in every country.

For information about availability, please visit [www.miele.com](http://www.miele.com).

## Miele App

You can download the Miele App from the Apple App Store® or the Google Play Store™ free of charge (only functional in selected countries).



## Standard settings

The following settings must be made before starting up for the first time. You can change these settings again at a later time (see “Settings”).

 Risk of injury caused by hot surfaces.

The oven gets hot during operation. For safety reasons, the oven may only be used when it has been fully installed.

The oven will switch on automatically when it is connected to the electricity supply.

## Setting the language

- Select the language you want.

If you have accidentally selected a language that you don't understand, proceed as described in “Settings – Language ”.

## Setting the location

- Select the required location.

## Setting up Miele@home

Set up Miele@home? appears in the display.

- To set up Miele@home immediately, select *Continue*.
- To set it up at a later date, select *Skip*. See “Settings – Miele@home” for information on setting up at a later date.
- To set up Miele@home immediately, select the desired connection method.

You will then be guided by the display and the Miele App.

## Setting the date

- Set the day, month and year.
- Confirm with *OK*.

## Setting the time of day

- Set the time of day in hours and minutes.
- Confirm with *OK*.

## Completing the commissioning process

- Follow any further instructions in the display.

The appliance is now ready for use.

## Before using for the first time

### Heating up the oven for the first time

When the oven is heated up for the first time, it may give off a slight smell. This can be eliminated by heating the empty oven for at least an hour.

Ensure that the kitchen is well ventilated while the appliance is being heated up for the first time. Prevent odours from escaping into other rooms.

- Remove any protective foil and stickers, except the data plate, from the oven and accessories.
- Take all accessories out of the oven compartment and clean them (see “Cleaning and care”).
- Before heating the oven up, wipe the interior with a damp cloth to remove any dust or bits of packaging that may have accumulated during storage and unpacking.
- Switch the oven on with the On/Off  sensor.

The main menu will appear.

- Select Oven functions .
- Select Fan Plus .

The recommended temperature will appear (160 °C).

The oven heating, lighting and cooling fan will switch on.

- Set the maximum possible temperature (250 °C).
- Confirm with *OK*.

Heat up the empty oven for at least one hour.

- Switch the oven off with the On/Off  sensor after at least one hour.

### Cleaning the oven compartment after heating it up for the first time

 Risk of injury caused by hot surfaces.





The oven gets hot during operation. You could burn yourself on the heating elements and the oven interior.

Allow the heating elements and oven compartment to cool down before manual cleaning.

- Clean the oven compartment with a clean sponge and a solution of hot water and washing-up liquid or a clean, damp microfibre cloth.
- Dry all surfaces with a soft cloth.

Leave the oven door open until the oven interior is completely dry.

## Settings overview

Menu option	Available settings
Language 	...   deutsch   english   ... Location
Time	Display On*   Off   Night dimming Clock type Analogue*   Digital Clock format 24 h*   12 h (am/pm) Set
Date	
Lighting	On "On" for 15 seconds* Off
Start screen	Main menu* Oven functions Automatic programmes Special applications User programmes MyMiele
Display	Brightness  * Colour scheme Bright   Dark* QuickTouch On   Off*
Volume	Buzzer tones  Keypad tone  Welcome melody On*   Off

\* Factory settings

# Settings

Menu option	Available settings
Units	Weight g*   lb   lb/oz Temperature °C*   °F
Quick MW	Power level Duration
Popcorn	Duration
Booster	On* Off
Recommended temperatures	
Recommended power levels	
Cooling fan run-on	Time-controlled Temperature-controlled*
Proximity sensor	Switch the light on during cooking process*   Always on   Off Switch the appliance on On   Off* Acknowledge buzzer On*   Off
Safety	System lock  On   Off* Sensor lock On   Off*
Furniture front recognition	On Off*
Miele@home	Activate Deactivate Connection status Set up again Reset Set up
Remote control	On* Off

\* Factory settings

Menu option	Available settings
SuperVision	SuperVision display On   Off* Display standby On   Only if there is a fault* Appliance list Display this appliance   Buzzer tones
RemoteUpdate	On* Off
Software version	
Legal information	Open source licences
Showroom programme	Demo mode On   Off*
Factory default settings	Appliance settings User programmes MyMiele Recommended power levels Recommended temperatures
Operating hours (total)	

\* Factory settings

# Settings

## Opening the “Settings” menu

In the  Settings menu, you can personalise your oven by adapting the factory default settings to suit your requirements.

From the main menu:

- Select  Settings.
- Select the desired setting.



You can check settings or change them.

Settings cannot be altered while a cooking programme is in progress.

## Language

You can set your language and location.

After selecting and confirming your choice, the language you have selected will appear in the display.

**Useful tip:** If you have selected the wrong language by mistake, select  in the main menu. Follow the  symbol to get back to the Language  sub-menu.

## Time

### Display

Select how you want the time of day to appear in the display when the oven is switched off:

- On  
The time is always visible in the display.  
If you also select the Display | QuickTouch | On setting, all sensor controls react to touch straight away and the proximity sensor automatically detects when you approach the display.  
If you also select the Display | QuickTouch | Off setting, the oven has to be switched on before it can be used.

- Off  
The display is dark to save energy. The oven has to be switched on before you can use it.
- Night dimming  
To save energy, the time is only visible in the display between 5:00 am and 11:00 pm. The display remains dark at all other times.

### Clock type

The time of day can be displayed in an Analogue (with a clock face) or Digital (h:min) format.

With the digital display, the date is also shown.

### Clock format

The time of day can be displayed in the 24 or 12-hour format (24 h or 12 h (am/pm)).

### Set

Set the hours and then the minutes.

**Useful tip:** If no cooking programme is in progress, touch the time in the header to change it.

If there is a power cut, the current time of day will reappear once power has been restored. The time of day is saved for approx. 150 hours.



If the oven has been connected to a Wi-Fi network and signed into the Miele App, the time will be synchronised based on the location setting in the Miele App.

### Date

Set the date.

When the oven is switched off, the date will only appear in the display if the Time | Clock type | Digital setting has been selected.

## Lighting

- On  
The oven interior lighting is switched on during the entire cooking period.
- "On" for 15 seconds  
The oven interior lighting switches off 15 seconds after a cooking programme has begun. Press the  sensor to switch the oven interior lighting on again for 15 seconds.
- Off  
The oven interior lighting is switched off. Press the  sensor to switch on the oven interior lighting for 15 seconds.

## Start screen

The oven is set at the factory for the main menu to appear when the oven is switched on. You can change this default setting so that, for instance, the oven functions or MyMiele settings appear in the display (see "MyMiele").

This new start screen will then appear when the oven is next switched on.

Select the  sensor or follow the path in the header to get to the main menu.

## Display

### Brightness

The display brightness is represented by a segment bar.

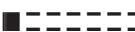
-   
Maximum brightness
-   
Minimum brightness

### Colour scheme

Choose between a light or dark colour scheme for the display.

- Bright  
The display has a light background with dark characters.
- Dark  
The display has a dark background with light characters.

## QuickTouch

Select how the sensors and the proximity sensor should respond when the oven is switched off:

- On  
If you have also selected the Time | Display | On or Night dimming setting, the sensors and the proximity sensor will also respond when the oven is switched off.
- Off  
Independently of the Time | Display setting, the sensors and the proximity sensor only respond when the oven is switched on, as well as for a certain amount of time after switching it off.



## Volume

### Buzzer tones

If buzzers are switched on, a buzzer will sound when the set temperature is reached and at the end of a set time.

If you want to open the door remotely using a voice-based service, make sure that nobody is in the area around the door when opening it. Make sure that you keep the buzzers switched on.

The volume of the buzzers is represented by a segment bar.

-   
Maximum volume
-   
Buzzers are switched off

# Settings

---

## Keypad tone

The volume of the tone that sounds each time you touch a sensor is represented by a segment bar.



Maximum volume



Keypad tone is switched off

## Welcome melody

The melody that sounds when you touch the On/Off  sensor can be switched on or off.

## Units

### Weight

For Automatic programmes, you can set the weight of food in grams (g), pounds (lb) or pounds/ounces (lb/oz).

### Temperature

You can set the temperature in degrees Celsius (°C) or degrees Fahrenheit (°F).

## Quick MW

The maximum microwave power level of 1000 W and the maximum cooking duration of 1 minute are preset for starting the microwave function immediately.

### - Power level

The following microwave power levels can be selected: 80 W, 150 W, 300 W, 450 W, 600 W, 850 W or 1000 W.

### - Duration

The maximum cooking duration that can be set depends on the microwave power level selected:

80–300 W: maximum 10 minutes

450–1000 W: maximum 5 minutes

## Popcorn

A microwave power level of 850 W and a cooking duration of 2:50 minutes is preset so that you can start cooking a bag of microwave popcorn immediately. These settings match the manufacturer's instructions on most bags of microwave popcorn.

The maximum cooking duration that can be set is 4 minutes.

The microwave power level is set and cannot be modified.

## Booster

The **Booster** function is used to quickly pre-heat the oven.

### - On

The **Booster** function is automatically switched on during the heating-up phase of a cooking programme. The top heat/grill element, ring heating element and hot air fan pre-heat the oven compartment to the desired temperature at the same time.

### - Off

The **Booster** function is switched off during the heating-up phase of a cooking programme. Only the heating elements for the selected oven function are used to pre-heat the oven compartment.

You can also use the pull-down menu to switch the **Booster** function on or off for a cooking programme.

## Recommended temperatures

If you frequently cook with different temperatures, it makes sense to change the recommended temperatures.

After selecting this option, a list of oven functions will appear in the display.

- Select the function you want.

The recommended temperature will appear together with the range within which it can be changed.

- Change the recommended temperature.
- Confirm with *OK*.

Changing the recommended temperatures also affects the corresponding function which uses microwave power.

## Recommended power levels

If you frequently cook with different power levels, it makes sense to change the recommended microwave power levels.

You can change the recommended power levels for the Microwave  function and for the functions which use microwave power.

After selecting this option, a list of functions will appear in the display together with their recommended power levels.

- Microwave :  
80 W, 150 W, 300 W, 450 W, 600 W, 850 W, 1000 W
- MW + Auto Roast , MW + Fan Plus , MW + Grill  and MW + Fan Grill :  
80 W, 150 W, 300 W

- Select the function you want.
- Change the recommended power level.
- Confirm with *OK*.

## Cooling fan run-on

The cooling fan will continue to run for a while after the oven has been switched off to prevent any humidity building up in the oven compartment, on the control panel or on the oven housing unit.

- Temperature-controlled  
The cooling fan switches off when the temperature in the oven drops below 70 °C.
- Time-controlled  
The cooling fan switches off after a period of about 25 minutes.

Condensate can damage the oven housing unit, damage the worktop and lead to corrosion in the oven.

If you have set the cooling fan to Time-controlled and leave food in the oven compartment to keep warm, moisture levels in the oven will increase, leading to condensation forming on the fascia panel and surrounding kitchen furniture, and drops of moisture collecting under the worktop.

Do not leave food in the oven to keep it warm if you have set the cooling fan to Time-controlled.

# Settings

---

## Proximity sensor

The proximity sensor detects when you approach the touch display, e.g. with your hand or body.

If you want the proximity sensor to respond even when the oven is switched off, select the **Display | QuickTouch | On** setting.

## Switch the light on

- during cooking process  
As soon as you approach the touch display during a cooking programme, the oven interior lighting switches on. The oven interior lighting automatically switches off again after 15 seconds.
- Always on  
As soon as you approach the touch display, the oven interior lighting switches on. The oven interior lighting automatically switches off again after 15 seconds.
- Off  
The proximity sensor does not respond when you approach the touch display. Select the **⊗** sensor to switch on the oven interior lighting for 15 seconds.

## Switch the appliance on

- On  
If the time is displayed, the oven switches on and the main menu appears as you approach the touch display.
- Off  
The proximity sensor does not respond when you approach the touch display. Switch the oven on with the **On/Off** **⏻** sensor.

## Acknowledge buzzer

- On  
As soon as you approach the touch display, the buzzers switch off.
- Off  
The proximity sensor does not respond when you approach the touch display. Switch the buzzers off manually.

## Safety

### System lock **🔒**

The system lock prevents the oven being switched on by mistake. You can still set an alarm and a minute minder as well as use the MobileStart function when the system lock is active.

The system lock will remain activated even after a power failure.

- On  
The system lock is switched on. If you want to use the oven, switch it on and touch the **🔒** symbol for at least 6 seconds.
- Off  
The system lock is deactivated. You can use the oven as normal.

### Sensor lock

The sensor lock prevents the cooking programme being switched off by mistake or settings being changed. Apart from the **On/Off** **⏻** sensor, the activated sensor lock prevents the sensors and fields in the display from working a few seconds after a programme has been started.

- On  
The sensor lock is switched on. Touch **OK** for at least 6 seconds to deactivate the sensor lock for a short period of time.
- Off  
The sensor lock is deactivated. All sensor controls react to touch as normal.

If you want to switch off the appliance with the sensor lock activated, touch the On/Off  sensor until the appliance switches off.

## Furniture front recognition

- On  
Furniture front recognition is activated. Using the proximity sensor, the oven automatically detects whether the furniture door is closed.  
If the furniture door is closed, the oven switches off automatically after a certain period.
- Off  
Furniture front recognition is deactivated. The oven does not detect whether the furniture door is closed.

If the oven is installed behind a furniture panel (e.g. a door), the oven, housing unit and the floor can be damaged by the build-up of heat and moisture behind the closed furniture panel.

Always leave the furniture door open when you are using the oven.

Leave the furniture door open until the oven has cooled down completely.

## Miele@home

The oven is a Miele@home compatible appliance with SuperVision functionality.

Your oven is fitted ex-works with a Wi-Fi communication module and is suitable for wireless communication.

There are a number of ways of connecting your oven to your Wi-Fi network. We recommend connecting your oven to your Wi-Fi network with the help of the Miele App or via WPS.

- Activate  
This setting is only visible if Miele@home is deactivated. The Wi-Fi function is reactivated.
- Deactivate  
This setting is only visible if Miele@home is activated. Miele@home remains set up, the Wi-Fi function is switched off.
- Connection status  
This setting is only visible if Miele@home is activated. The display shows information such as the Wi-Fi reception quality, network name and IP address.
- Set up again  
This setting is only visible if a Wi-Fi network has already been set up. Reset the network settings and immediately set up a new network connection.
- Reset  
This setting is only visible if a Wi-Fi network has already been set up. The Wi-Fi function is deactivated and the Wi-Fi network will be reset to the factory default. You must set up a new connection to the Wi-Fi network to be able to use Miele@home. The network settings should be reset

# Settings

whenever the oven is being disposed of or sold, or if a used oven is being put into operation. This is the only way to ensure that all personal data has been removed and, in the case of the latter, the previous owner will no longer be able to access the oven.

- Set up  
This setting is only visible if no connection to the Wi-Fi network has been set up yet. You must set up a new connection to the Wi-Fi network to be able to use Miele@home.

## Performing Scan & Connect

Initial commissioning has been carried out without Miele@home having been set up.

- Scan the QR code.

If you have installed the Miele App and have a user account, you will be taken directly to the networking steps.

If you have not yet installed the Miele App, you will be taken to the Apple App Store® or the Google Play Store™.

- Install the Miele App and set up a user account.
- Scan the QR code again.

The Miele App will guide you through the set-up process.



## Remote control

If you have installed the Miele App on your mobile device, have access to the Miele@home system and have activated the remote control function (On), you can use the MobileStart function to retrieve information on oven cooking programmes currently in progress or to end a programme in progress.

### Activating MobileStart

- Select the  sensor to activate MobileStart.

The  sensor lights up. You can operate your oven remotely with the Miele App.

Directly operating the oven takes priority over operating it via the remote control function on the App.

You can use MobileStart as long as the  sensor is lit up.

## SuperVision

The oven is a Miele@home compatible appliance with SuperVision functionality for monitoring other household appliances in the Miele@home system.

The SuperVision function cannot be activated until the Miele@home system has been set up.

### SuperVision display

- On  
The SuperVision function is switched on.  
The  symbol will appear in the top right-hand corner of the display.
- Off  
The SuperVision function is switched off.

## Display standby

The SuperVision function is also available when the oven is in standby. However, the time of day display must be switched on (Settings | Time | Display | On).

- On  
Active domestic appliances that are signed on to the Miele@home system are always displayed.
- Only if there is a fault  
Only faults on active domestic appliances are displayed.

## Appliance list

All household appliances signed on to the Miele@home system are displayed. Once you have selected an appliance, you can access further settings:

- Display this appliance
  - On  
The SuperVision function for this appliance is switched on.
  - Off  
The SuperVision function for this appliance is switched off. The appliance is still signed on to the Miele@home system. Faults are displayed, even if the SuperVision function for the appliance has been switched off.
- Buzzer tones  
You can select whether the buzzers are switched on (On) or switched off (Off) for this appliance.

## RemoteUpdate

The RemoteUpdate menu option is only displayed and can only be selected if the requirements for using Miele@home have been met (see “Before using for the first time – Miele@home” or “Settings – Miele@home”).

The RemoteUpdate function is used for updating the software in your oven. If an update is available for your oven, it will automatically download it. Updates will not be installed automatically. They must be initiated manually.

If you do not install an update, you can continue to use your oven as usual. However, Miele recommends installing updates.

## Switching on/Switching off

RemoteUpdate is switched on as standard. Available updates will be downloaded automatically and will only be installed if you initiate it.

Switch off RemoteUpdate if you do not wish any updates to be downloaded.

## Running a RemoteUpdate

Information about the content and scope of an update is provided in the Miele App.

A message will appear in your oven display if a software update is available. You can install the update immediately or postpone this until later. When the oven is switched on again, you will be reminded about the update.

Switch RemoteUpdate off if you do not wish to install updates.

The update can take several minutes.

# Settings

---

Please note the following information about the RemoteUpdate function:

- You will only receive a message when an update is available.
- Once an update has been installed, it cannot be undone.
- Do not switch the oven off during the update. Otherwise, the update will be aborted and will not be installed.
- Some software updates can only be carried out by a Miele service technician.

## Software version

The software version menu option is for use by Miele service technicians. You do not need this information for domestic use.

- Confirm with *OK*.

## Legal information

You can find an overview of the integrated Open Source components under Open source licences.

- Confirm with *OK*.

## Showroom programme

This function enables the oven to be demonstrated in showrooms without heating up. Do not activate this setting for domestic use.

## Demo mode

If you switch the oven on whilst it is in Demo mode, the following message will appear in the display: Demo mode is switched on. The appliance will not heat up..

- On  
Touch *OK* for at least 4 seconds to activate Demo mode.
- Off  
Touch *OK* for at least 4 seconds to deactivate Demo mode. You can use the oven as normal.

## Factory default settings

- Appliance settings  
Any settings that have been altered will be reset to the factory default settings.
- User programmes  
All User programmes will be deleted.
- MyMiele  
All MyMiele entries will be deleted.
- Recommended power levels  
Microwave power levels which have been changed will be reset to the factory default settings.
- Recommended temperatures  
Any recommended temperatures that have been changed will be reset to the factory default settings.

## Operating hours (total)

Select Operating hours (total) to query the total number of operating hours of your oven.

Using the  sensor, you can set a minute minder duration to time any activity in the kitchen, e.g. boiling eggs on the cooktop, or an alarm for a specific time.



Two alarms can be set simultaneously, two minute minder durations or an alarm and a minute minder duration.

## Using the Alarm function

The  alarm can be used to specify a particular time for a buzzer to sound.

### Setting the alarm

If the Display | QuickTouch | Off setting is selected, you will need to switch the oven on before setting the alarm. The alarm time will then appear in the display when the oven is switched off.

- Select the  sensor.
- Select  Alarm.
- Set the time for the alarm.
- Touch  to confirm.

When the oven is switched off, the alarm time and  will appear instead of the time of day.

If you are cooking at the same time or if you are in a different menu, the alarm time and  will appear in the top right-hand corner of the display.

At the specified time for the alarm,  will flash in the display next to the time and a buzzer will sound.

- Select the  sensor or the set alarm time in the display.

The buzzer will stop and the symbols in the display will go out.

### Changing an alarm

- Select the alarm in the display or select the  sensor and the desired alarm.

The set alarm time appears in the display.

- Set the new time for the alarm.
- Touch  to confirm.

The adjusted alarm time is now saved and will appear in the display.

### Deleting an alarm

- Select the alarm in the display or select the  sensor and the desired alarm.

The set alarm time appears in the display.

- Select Delete.
- Touch  to confirm.

The alarm will be deleted.

# Alarm + minute minder

---

## Using the Minute minder function



The  minute minder can be used to time other activities in the kitchen, e.g. boiling eggs on the cooktop.

The minute minder can also be used at the same time as a cooking programme for which the cooking duration start and finish times have been set (e.g. as a reminder to stir the food or add seasoning, etc.).

- The maximum minute minder time that can be set is 59 minutes and 59 seconds.

## Setting the minute minder

If you have selected the Display | QuickTouch | Off setting, you will need to switch the oven on before setting the minute minder. The minute minder can then be seen counting down in the display when the oven is switched off.

- Select the  sensor.
- Select  Minute minder.
- Set the minute minder time you require.
- Touch **Close** to confirm.

When the oven is switched off, the minute minder time counts down in the display and  appears instead of the time of day.

If you are cooking at the same time or if you are in a different menu, the minute minder time and  will appear in the top right-hand corner of the display.

At the end of the minute minder time  will flash, the time will start counting up and a buzzer will sound.

- Select the  sensor or the required minute minder in the display.

The buzzer will stop and the symbols in the display will go out.

## Changing the time set for the minute minder

- Select the minute minder in the display or select the  sensor and then the required minute minder duration.

The minute minder time selected appears.

- Set a new minute minder duration.
- Touch **Close** to confirm.

The changed minute minder duration is now saved and will count down in minutes. Minute minder durations under 10 minutes will count down in seconds.

## Cancelling the minute minder

















- Select the minute minder in the display or select the  sensor and then the required minute minder duration.

The minute minder time selected appears.





- Select **Delete**.
- Touch **Close** to confirm.

The minute minder is now cancelled.

## Main and sub-menus

Menu	Recommended value	Range
Oven functions 		
Fan Plus 	160 °C	30–250 °C
Conventional Heat 	180 °C	30–250 °C
Microwave 	1000 W	80–1000 W
MW combi 	300 W	80–300 W
MW + Fan Plus 	160 °C	30–220 °C
MW + Fan Grill 	200 °C	100–200 °C
MW + Grill 	3	1–3
MW + Auto Roast 	160 °C	100–200 °C
Intensive Bake 	170 °C	50–220 °C
Auto Roast 	160 °C	100–230 °C
Bottom Heat 	190 °C	100–200 °C
Grill 	3	1–3
Fan Grill 	200 °C	100–220 °C
Eco Fan Heat 	190 °C	100–230 °C
Automatic programmes 		

## Main and sub-menus

Menu	Recommended value	Range
Special applications 		
Defrost	–	–
Drying	60 °C	30–70 °C
Reheat	–	–
Heat crockery	80 °C	50–100 °C
Prove yeast dough	35 °C	30–50 °C
Low temp. cooking	90 °C	80–120 °C
Keeping warm	75 °C	60–90 °C
MyMiele  		
User programmes 		
Settings 		

## How it works

The oven contains a magnetron that converts electrical energy into electromagnetic waves (microwaves). These microwaves are distributed evenly throughout the oven compartment and are reflected off the metal appliance walls.

The microwaves penetrate the food from all sides. Food consists of many molecules. When subjected to microwave energy, these molecules (particularly the water molecules) start to oscillate. This heats the food from the outside to the inside. The more water a food contains, the faster it is heated or cooked.

## Advantages of the microwave oven

- Food can generally be cooked with little or no liquid or cooking oil.
- The times for defrosting, reheating or cooking are shorter than with a cooktop or oven.
- Vitamins, minerals, natural colour, and taste of the food are generally retained.

If the oven is used without food or the food is loaded incorrectly when using the Microwave  function or functions that use microwave power, the oven can become damaged.

**Always** use the glass tray with the Microwave  function, even if you use it as a container for smaller dishes.

## Suitable crockery

In order for microwaves to reach the food, they must be able to penetrate the crockery being used. Microwaves can pass through porcelain, glass, cardboard and plastics, but not metal. Therefore, do not use metal containers or crockery that contains metal. Metal reflects the microwaves which can create sparks and the microwaves are not absorbed by the metal.

 Risk of injury from increased pressure in sealed containers or bottles.

Pressure can build up when reheating food or drinks in sealed containers, jars or bottles, which can cause them to explode.

Never cook or reheat solid or liquid food in sealed containers or bottles. Open containers beforehand. In the case of baby bottles, the screw top and teat must be removed.

 Fire hazard due to using unsuitable crockery for functions which use microwave power.

Non-microwave safe dishes used in microwave mode can suffer damage or cause damage to the oven.

Only use microwave safe crockery for functions which use microwave power.

The material and shape of containers used affect cooking results and times. Heat distribution is more even in round and oval shaped flat containers than in rectangular containers, providing better results.

# Microwave operation

## Suitable containers

 Fire hazard due to inflammable materials.

Disposable containers made out of plastic, paper or other inflammable materials can ignite, causing damage to the oven.

Do not leave the oven unattended when reheating or cooking food in disposable containers made of plastic, paper or other inflammable materials.

You can use the following crockery and material:

- Heat-resistant glass and ceramic glass  
Exception: crystal glass as it contains lead and may crack.
- Porcelain
  - Without metallic decoration  
Metallic decoration (e.g. gold rims or cobalt blue) can cause sparking.
  - Without hollow knobs and handles  
Moisture can gather in the hollow knobs and handles. When the moisture evaporates, pressure can build up and the item can explode.

- Unpainted stoneware and stoneware with underglaze paints

 Risk of injury caused by hot crockery.

Earthenware can get very hot and may crack.





Wear oven gloves when using stoneware.

- Plastic containers and plastic disposable containers with the Microwave  function

**Useful tip:** To protect the environment, avoid the use of disposable containers.

Plastics must be heat-resistant to a minimum of 110 °C. Otherwise the plastic may melt and fuse with the food.

Only use plastic containers with the Microwave  function.

Do not use plastic containers with the MW + Auto Roast , MW + Fan Plus , MW + Grill  or MW + Fan Grill  functions.

- Microwave safe plastic containers  
Special plastic containers designed for use in microwave ovens are available from retail outlets.
- Styrofoam containers  
For briefly heating food.
- Plastic boiling bags  
For cooking and reheating. They should be pierced beforehand. The holes allow the steam to escape. This prevents a build-up of pressure from forming and the bag from bursting. There are also special bags available for steam cooking which do not need to be pierced. Please follow the instructions given on the packet.

## Microwave operation









- Roasting bags and tubes  
Please follow the manufacturer's instructions.

 Fire hazard due to metal parts.

Metal parts such as metal clips or plastic and paper ties that have wire running through them can heat inflammable materials until they burn.

Do not use metal clips, or plastic and paper ties containing wire.

**Useful tip:** Metal tins are less suitable for functions which use microwave power because the metal reflects the microwaves. The microwaves only reach the cake from above, which extends the baking time. If you use metal tins, place the tin on the glass tray so that it cannot touch the oven walls. If sparks form, do not reuse the tin for functions which use microwave power.

- The **supplied** rack is only suitable for cooking programmes with the MW + Auto Roast , MW + Fan Plus , MW + Grill  and MW + Fan Grill  functions, as well as for functions which do not use microwave power (placed on one level)
- Metal baking tins for baking with the MW + Auto Roast , MW + Fan Plus , MW + Grill  and MW + Fan Grill  functions as well as for functions which do not use microwave power

- Aluminium foil trays without lids for defrosting and reheating ready meals  
The food is only heated from the top. If you remove the food from the aluminium foil container and transfer it to crockery suitable for use in a microwave oven, the heat distribution will generally be more even.

Using aluminium foil trays and aluminium foil can cause crackling and sparks.

Therefore, place aluminium foil trays on the glass tray and not on the rack. Aluminium foil and aluminium foil trays must not touch the oven compartment walls and must remain at least 2 cm from the walls at all times.

- Metal meat skewers or clamps  
The size of the cut of meat must be much larger than the metal skewers and clamps.

# Microwave operation

## Unsuitable containers

Crockery and lids with hollow handles or knobs can collect moisture in the hollow spaces. When the moisture evaporates, pressure can build up and the item can explode. If the hollow recess is sufficiently ventilated, the item can be used.

Do not use crockery with hollow knobs or handles for cooking.

Do **not** use the following crockery and material:

- Metal racks (including the supplied rack) are **not** suitable for use with the Microwave  function
- Metal containers
- Aluminium foil  
Exception: for even defrosting, reheating or cooking unevenly shaped cuts of meat, e.g. poultry, small pieces of aluminium foil may be used to cover thin parts for the last few minutes of the programme
- Metal clips, plastic or paper ties containing wire
- Plastic containers where the aluminium lid has not been completely removed
- Crystal glass
- Cutlery and crockery with metallic decoration (e.g. gold rims, cobalt blue)
- Crockery with hollow handles
- Plasticware made of melamine  
Melamine absorbs microwave energy and gets hot.  
When purchasing plasticware, make sure that it is suitable for use in a microwave oven.

- Wooden dishes  
Water contained in wood evaporates during the cooking programme. This causes the wood to dry and crack.

## Testing dishes for their suitability

Unsuitable crockery can cause sparks or crackling noises in microwave operation. If you are not sure whether glass, porcelain or stoneware crockery is suitable, test the dishes.

This test cannot be used to check whether items with hollow knobs or handles are suitable for use.

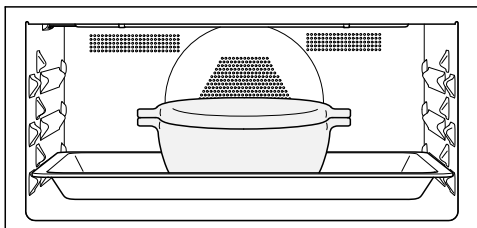

- Place the empty crockery in the middle of the glass tray and insert the tray in shelf level 1.
- Close the door.
- Select the Microwave  function.
- Set the highest microwave power level (1000 W) and a cooking duration of 30 seconds.
- Start the programme.
- Observe the crockery during the entire duration.
- Immediately open the door if there are sparks or crackling noises.

If there are sparks or if you can hear crackling noises, the tested crockery is not suitable for microwave use.

## Cover

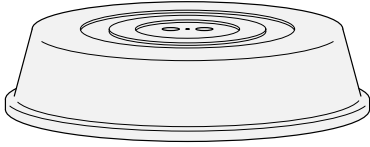



**Useful tip:** Covers are available from retail outlets.

- A cover prevents too much steam escaping, especially when cooking foods which need longer to cook.
- It speeds up the heating process of the food.
- It prevents food from drying out.
- It helps keep the oven interior clean.

- Use a glass or plastic cover suitable for microwave use for cooking programmes with the Microwave  function.

Alternatively, use a cling film suitable for use in a microwave oven. Heat can cause normal cling film to distort and fuse with the food.





The cover must be able to withstand temperatures of up to 110 °C. At higher temperatures (e.g. in the Grill  or Fan Plus  functions), the plastic may distort and fuse with the food.

Only use a cover for the Microwave  function.

The cover should not form a seal with the container. If the container has a narrow diameter, the steam may not be able to escape. The cover could get too hot and start to melt.

Use containers with a sufficiently large diameter.

- Do **not** use a cover for reheating the following types of food:

- Food coated in breadcrumbs
- Food which requires a crisp finish, e.g. toast
- Food which must be heated with the MW + Auto Roast , MW + Fan Plus , MW + Grill  or MW + Fan Grill  functions

## Operation

If you place food directly on the floor of the oven when using the Microwave  function, the oven can become damaged.

When using the Microwave  function, place the glass tray on shelf level 1 and **always** place cooking containers on the glass tray.

- Switch the oven on.

The main menu will appear.

- Place the food in the oven.
- Select Oven functions .
- Select the function you want.

The function will appear in the display. Depending on the function, the recommended power level, recommended temperature and the cooking duration will appear in the display.

- Change the recommended values for the cooking programme and set the cooking duration if required.

You can change the recommended values later by selecting the relevant value or Timer.

- Touch *OK* to start the cooking programme for functions which **do not use** microwave power.
- Touch *Start* to start the cooking programme for functions which **use** microwave power.

The set values appear and the cooking duration counts down in the display for all functions.

If you have set a temperature, you will see the temperature increasing. A buzzer will sound when the selected temperature is reached for the first time.

The oven stops generating microwave power when you interrupt the cooking programme with *Stop* or open the door. You can continue the programme with *Start*.

- After the cooking programme, select *Finish* or *Close* (depending on the function).
- Take the food out of the oven.
- Switch the oven off.

### Changing values and settings for a cooking programme

Depending on the function, as soon as a cooking programme is in progress, you can change the values or settings for this programme.

Depending on the function, you can change the following settings:

- Temperature
- Power level
- Duration
- Finish at
- Start at
- Booster
- Pre-heat
- Crisp function

## Changing the temperature and core temperature

Via Settings | Recommended temperatures, you can permanently adjust the recommended temperature to suit your cooking preferences.

The  core temperature only appears if you are using the food probe (see “Roasting – Food probe”).

- Touch the temperature display.
- Change the temperature and the  core temperature as required.
- Confirm with *OK*.

The cooking programme will resume with the new target temperatures.

## Changing the microwave power level

You can also permanently reset the recommended power level to suit your cooking preferences. See Settings | Recommended power levels.

- Touch the microwave power level display.
- Change the microwave power level.
- Select Start.

The process will restart with the new microwave power level.

## Setting cooking durations

Cooking results can be adversely affected if there is a long delay between the food being placed in the oven and the start of cooking. Fresh food can change colour and even spoil.

When baking, the cake mixture or dough can dry out, and the raising agents can lose their effectiveness.

Select as short a time as possible until the start of the cooking process.

Example: You have placed the food in the oven compartment, selected a function and the required settings such as the temperature.

By entering Duration, Finish at or Start at, you can automatically switch the cooking programme off or on and off.

- Duration

Enter the required cooking duration for the food. The heating will switch off automatically once this duration has elapsed. The maximum cooking duration that can be set depends on the function that you have selected.

- Finish at

Specify when you want the cooking programme to finish. The oven heating will switch off automatically at the time you have set.

- Start at

This function will only appear in the menu if you have set a Duration or Finish at time. With Start at, you have to specify when you want the cooking programme to start. The oven heating will switch on automatically at the time you have set.

- Select  or Timer.
- Set the required times.
- Confirm with *OK*.

# Operation

---

## Changing the set cooking durations

- Select , the duration or Timer.
- Select the desired time and change it.
- Confirm with *OK*.

These settings will be deleted in the event of a power failure.

## Deleting the set cooking durations

- Select , the duration or Timer.
- Select the time you want.
- Select Delete.
- Confirm with *OK*.

If you delete Duration, the set times for Finish at and Start at are also deleted.

If you delete Finish at or Start at, the cooking programme will start using the cooking duration set.

## Interrupting a cooking programme in the Microwave function

You can interrupt cooking when using the Microwave  function and pause the cooking duration.

While the cooking duration is counting down, Stop appears in the bottom right of the display.

- Select Stop.

Cooking is interrupted and the cooking duration is paused.

Start is highlighted in green.

- Select Start.

The cooking programme resumes and the cooking duration continues to count down.

## Cancelling cooking

If you cancel a cooking programme, the oven heating and lighting will switch off. Any cooking durations set will be deleted.

### Cancelling a cooking programme without a set cooking duration

- Select Finish.

The main menu will appear.

### Cancelling a cooking programme with a set cooking duration

- Select Cancel.

Cancel process? appears in the display.

- Select Yes.

The main menu will appear.

## Pre-heating the oven



The Booster function is used to quickly heat up the oven compartment in some functions.

The Pre-heat function can be used with any function (except Microwave ) and has to be switched on separately for each cooking programme.

If you have set a cooking duration, it will only start to count down when the target temperature is reached and you have placed the food in the oven.

It is only necessary to pre-heat the oven in a few instances.





- Most dishes can be placed in a cold oven. They will then make use of the heat produced during the heating-up phase.
- Pre-heat the oven for the following preparations and oven functions:

- Dark bread dough and beef sirloin joints and fillet with the Fan Plus  and Conventional Heat  functions
- Cakes and pastries with a short cooking duration (approx. 30 minutes or less) as well as delicate items (e.g. sponge) with the Conventional Heat  function (without the Booster function)

## Booster

The Booster function is used to quickly pre-heat the oven compartment in some functions.

This function is switched on as the factory default setting for the following functions (Settings | Booster | On):

- Fan Plus 
- Conventional Heat 
- Auto Roast 
- MW + Fan Plus 
- MW + Auto Roast 

If you set a temperature above 100 °C and the Booster function is switched on, a rapid heating-up phase heats the oven compartment to the set temperature. The top heat/grill element and the ring heating element come on together with the hot air fan.

Delicate items (e.g. sponge or biscuits) will brown too quickly on the top if the Booster function is used. Switch off the Booster function for these items.

## Switching Booster on or off for a cooking programme

If you have selected the Booster | On setting, you can switch off the function separately for a cooking programme.

On the other hand, you can also switch on the function separately for a cooking programme if you have selected the Booster | Off setting.

Example: You have selected a function and the required settings such as the temperature. You want to switch off the Booster function for this cooking programme.

- Drag down the pull-down menu. Booster is highlighted in orange.
- Select Booster.

Depending on the colour scheme, Booster is highlighted in either black or white.

- Close the pull-down menu.

The Booster function is switched off during the heating-up phase. Only the heating elements for the selected oven function are used to pre-heat the oven compartment.

## Pre-heat

It is only necessary to pre-heat the oven in a few instances.

You can place most dishes in the cold oven compartment to make use of the heat produced during the heating-up phase.

If you have set a cooking duration, it will only start to count down when the target temperature is reached and you have placed the food in the oven.

Start the cooking programme immediately without delaying the start time.

The Pre-heat function is not available with the Microwave  operating mode.

# Operation

---

## Switching on the Pre-heat function

The Pre-heat function can be used with any oven function and has to be switched on separately for each cooking programme.

Example: You have selected a function and the required settings such as the temperature.

You want to switch on the Pre-heat function for this cooking programme.

- Drag down the pull-down menu.

Depending on the colour scheme, Pre-heat is highlighted in either black or white.

- Select Pre-heat.

Pre-heat is highlighted in orange.

- Close the pull-down menu.

The following message is displayed with a time: Place food in the oven at ... The oven compartment is heated to the set temperature.

- As soon as you are prompted to do so, place the food in the oven compartment.
- Confirm with *OK*.

## Crisp function

It is a good idea to use the Crisp function (moisture reduction) when cooking food which has a moist topping e.g. quiche, pizza, tray bakes with fresh fruit toppings or muffins.

Poultry in particular gets a good crisp skin with this function.

## Switching on the Crisp function

The Crisp function can be used with any oven function and has to be switched on separately for each cooking programme.

Example: You have selected a function and the required settings such as the temperature.

You want to switch on the Crisp function for this cooking programme.

- Drag down the pull-down menu.

Depending on the colour scheme, Crisp function is highlighted in either black or white.

- Select Crisp function.

Crisp function is highlighted in orange.

- Close the pull-down menu.

The Crisp function is switched on.

## Changing the function

You can change to another function during a cooking programme.

- Touch the symbol for the selected function.
- If you have set a cooking duration, confirm the *Cancel process?* message with *Yes*.
- Select the new function.

The new function appears in the display with its corresponding recommended values.

- Set the values for the cooking programme and confirm with *OK*.

These functions can only be used when no other cooking programmes are in use.

Always use the glass tray.

## Quick MW

If you select the  sensor, the oven starts with a set microwave power level and cooking duration, e.g. to reheat a drink.

The maximum power level of 1000 W and a maximum duration of 1 minute are preset.

You can change the microwave power level and the cooking duration. The maximum cooking duration that can be set depends on the microwave power level selected (see “Settings – Quick MW”).

- Select the  sensor.  
Touching the sensor repeatedly increases the cooking duration in increments.

The time left will appear in the display.

You can interrupt the cooking programme at any time with Stop, or cancel it by selecting the  sensor.

At the end of the cooking programme, Finished appears in the display and a buzzer sounds.

- Select Close.

The main menu will appear.

## Popcorn

If you select the  sensor, the oven starts with a set microwave power level and cooking duration.

A microwave power level of 850 W and a maximum cooking duration of 2:50 minutes are preset. These settings match the manufacturer’s instructions on most bags of microwave popcorn.

The maximum cooking duration that can be set is 4 minutes. The microwave power level is set and cannot be modified (see “Settings – Popcorn”).

- Select the  sensor.

The time left will appear in the display.

You can interrupt the cooking programme at any time with Stop, or cancel it by selecting the  sensor.

Disposable containers made out of paper or other inflammable materials can ignite, causing damage to the oven.

Do not leave the oven unattended during this programme and make sure you follow the instructions on the packaging.

At the end of the cooking programme, Finished appears in the display and a buzzer sounds.

- Select Close.

The main menu will appear.

# Automatic programmes

---

The wide range of Automatic programmes enable you to achieve excellent results with ease.

## Categories

The  Automatic programmes are sorted into categories to provide a better overview. Simply select the appropriate Automatic programme for the type of food you are cooking and follow the instructions in the display.

## Using Automatic programmes

- Select Automatic programmes .

A list will appear.

- Select the desired food category.

The Automatic programmes available for the food type selected will then appear.

- Select the Automatic programme that you want to use.
- Follow the instructions in the display.

Some Automatic programmes will prompt you to use the food probe. Read the information under “Roasting – Food probe”.

The core temperature cannot be changed for the Automatic programmes.

**Useful tip:** Use  Info to display information such as how to place or turn the food depending on the cooking programme.

## Usage notes

- When using Automatic programmes, the recipes provided are designed as a guide only. Other similar recipes, including those using different quantities, can be used for the Automatic programme in question.
- After cooking, allow the oven compartment to cool down to room temperature again before starting an Automatic programme.
- Some Automatic programmes require a pre-heating phase before food can be placed in the oven. A prompt will appear in the display indicating when this needs to be done.
- Some Automatic programmes require the addition of liquid after a certain cooking duration. You will be prompted by a message in the display when this needs to be done (e.g for adding liquid).
- The duration quoted for Automatic programmes is an estimate. It may increase or decrease depending on the programme. The duration, in particular with meat, will vary depending on the initial temperature of the food.
- When using the food probe, the cooking duration will depend on when the core temperature is reached.
- If by the end of an Automatic programme the food is not cooked enough, select *Continue cooking* or *Continue baking*. Conventional heating will then be used for 3 minutes to continue cooking or baking the food.

## Search

(Depending on language)

Under Automatic programmes, you can search by the name of the categories and the Automatic programmes.

There is a full text search which can also be used to search for parts of words.

From the main menu:

- Select Automatic programmes .

The category list will appear in the display.

- Select Search.
- Use the keyboard to type in the search text, e.g. "Bread".

The number of hits will be shown in the footer.

If no match is found, or if there are more than 40 matches, the hits field will be deactivated and you will need to change the search text.

- Select XX hits.

The categories and Automatic programmes found will then appear.

- Select the desired Automatic programme, or the category and then the Automatic programme.

The Automatic programme will start.

- Follow the instructions in the display.

# Special applications



---

This section provides information on the following applications:

- Defrost
- Drying
- Reheat
- Heat crockery
- Prove yeast dough
- Low temp. cooking
- Keeping warm
- Cooking
- Bottling
- Frozen food/Ready meals

## Defrost

Gentle defrosting of frozen goods means that the vitamins and minerals are generally retained.

- Use one of the following functions and special applications:
  - Special applications  | Defrost  
Select a category and the weight for the food.
  - Oven functions  | Microwave   
Set the microwave power level and the defrosting duration.

 Risk of infection from bacteria. Bacteria such as salmonella can cause life-threatening food poisoning. It is particularly important to observe food hygiene rules when defrosting fish and meat, and in particular when defrosting poultry. Do not use the liquid produced during defrosting. Process the food as required as soon as it has been defrosted.

## Useful tips

- Place the food to be defrosted on the glass tray without its packaging.
- For defrosting poultry, use the glass tray with the rack placed on top of it. This way the frozen food will not be lying in the defrosted liquid.
- Meat and poultry need to be fully defrosted before cooking. Fish, on the other hand, can be partially defrosted before cooking. Defrost so that the surface is sufficiently soft to take herbs and seasoning.

### Using the Defrost Special application

This programme has been developed for gently defrosting frozen food.

Only use heat-resistant containers which are microwave safe.

- Select Special applications .

- Select Defrost.

A list will appear.

- Select the type of food.
- Enter the weight of the food.

You can start the defrosting process immediately or delay the start and display the individual actions and cooking stages.

- Follow the instructions in the display.

### Useful tips

- Use **i** Info to display information such as when to turn the frozen goods depending on the cooking programme.
- If the frozen food is not defrosted properly by the end of the defrosting process, select *Continue keeping warm*. The frozen food will continue to be heated for 3 minutes.
- After the defrosting process has ended, select *Save* to save the settings for the selected category and weight as a User programme (see "User programmes").

### Using the Microwave function

Instead of the Special application, you can use the Microwave  function for defrosting. Set the microwave power level and the defrosting duration.

The time required depends on the nature of the food, its initial temperature and the amount to be cooked. Take note of the standing times.

Only use heat-resistant containers which are microwave safe.



- Select Oven functions .

- Select Microwave .

- Depending on the type of food, set the microwave power level and the defrosting duration specified in the chart.
- You are generally advised to select the middle duration.
- Place the food on the glass tray on shelf level 1 in the oven.

## Special applications

### Defrosting with the Microwave function

Food to be defrosted	Quantity	 [W]	 [min.]	 [min.] <sup>1</sup>
Butter	250 g	80	8–10	5–10
Milk	1000 ml	450	12–16	10–15
Sand cake (3 slice)	Approx. 300 g	150	4–6	5–10
Fruit cake (3 slices)	Approx. 300 g	150	6–8	10–15
Butter cake (3 slices)	Approx. 300 g	150	6–8	5–10
Cream cake (3 slices)	Approx. 300 g	80	4– 4:30	5–10
Yeast buns, puff pastries (3 pieces)	Approx. 300 g	150	6–8	5–10

 Microwave power level,  Defrosting duration,  Standing time

<sup>1</sup> Allow food to stand at room temperature. This allows the heat to spread evenly throughout the food.

# Special applications





## Drying



Drying is a traditional method of preserving fruit, certain vegetables and herbs.

It is important that fruit and vegetables are ripe and not bruised before they are dried.

- Prepare the food for drying by cutting it up, and peeling and coring it if necessary.
- Distribute the food for drying evenly in a single layer according to size over the rack or the glass tray.
- Dry on a maximum of 2 levels at the same time.  
Place the food for drying on shelf levels 1+2.  
If you are using both the rack and glass tray, insert the glass tray below the rack.
- Select Special applications .
- Select Drying.
- Alter the recommended temperature if necessary and then set the drying time.
- Follow the instructions in the display.
- Turn the food for drying on the glass tray at regular intervals.

The drying times are longer for whole or halved food.

Food		🌡️ [°C]	🕒 [h]
Fruit		60–70	2–8
Vegetables		55–65	4–12
Mushrooms		45–50	5–10
Herbs*		30–35	4–8

- Special application/Function,
- 🌡️ Temperature, 🕒 Drying time,
-  Drying Special application,
-  Conventional Heat function

\* Dry herbs only on the glass tray on level 2 and use the Conventional Heat  function, as the fan is switched on in the Drying Special application.

- Reduce the temperature if condensation begins to form in the oven.

## Removing the dried food

 Risk of injury caused by hot surfaces.

The oven gets hot during operation. You could burn yourself on the heating elements, the oven compartment, or accessories. Use oven gloves when removing dried food from the oven.

- Allow the dried fruit or vegetables to cool down after drying.

Dried fruit needs to be completely dry, but also soft and elastic. Juice should not escape when cut.

- Store dried food in sealed glass jars or tins.

# Special applications

## Reheat

It is essential that “Warning and Safety instructions - Correct use” is observed.

 Risk of injury caused by hot food.

If food for babies and children is heated at too high a temperature, they can burn themselves.

Only heat food for babies and children for 30–60 seconds at 450 W. The food probe can be used to monitor the temperature when reheating.

After heating food, especially food for babies and small children, stir the food or shake the container and taste the food so that children do not get burned.

 Risk of injury from increased pressure in sealed containers or bottles.

Pressure can build up when reheating food or drinks in sealed containers, jars or bottles, which can cause them to explode.

Never cook or reheat food or liquids in sealed containers or bottles. Open containers beforehand. In the case of baby bottles, the screw top and teat must be removed.

Risk of injury caused by hot liquids.

When heating food, and in particular liquids, using the

Microwave  function, the boiling point may be reached without the production of typical bubbles. Liquids do not boil evenly throughout.

This boiling delay can result in the liquid boiling over explosively. Take care when taking the container out of the oven, as the hot liquid can cause severe scalding. Under certain circumstances, the pressure can be so high that the door opens automatically.

Stir liquids well before reheating or cooking.

After heating, wait at least 20 seconds before removing the container from the oven.

In addition, a glass rod or similar item, if available, can be placed in the container during heating.

## Using the Reheat Special application

This programme is designed for reheating food.

The time required depends on the nature of the food, its initial temperature and the amount to be cooked. For example, food taken straight from the refrigerator takes longer to reheat than food which has been kept at room temperature. Take note of the standing times.

Only use heat-resistant containers which are microwave safe.

Always cover food when reheating it, except when reheating meat/fish coated in breadcrumbs.

- Place the food that is to be reheated on the glass tray with a cover.
  - Select Special applications .
  - Select Reheat.
- A list will appear.
- Select the type of food.
  - Enter the weight of the food.
  - Follow the instructions in the display.

 Risk of burning due to hot surfaces!

The oven gets hot during operation. You could burn yourself on the heating elements, the oven compartment, or accessories. Droplets of water may have accumulated underneath the crockery.

Use oven gloves when working in the hot oven compartment and when removing the crockery.

During the standing time, the temperature is distributed evenly in the food.



- After heating, allow the food to stand at room temperature for a few minutes to enable the heat to spread evenly throughout the food.

## Useful tips

- Always cover food when reheating it, except when reheating meat/fish coated in breadcrumbs.
- Use  Info to display information such as when to turn or stir the food. Stir the food from the outside towards the middle, as food heats more quickly from the outside.
- If the food is not hot enough at the end of the programme, select Continue keeping warm. The food will continue to be heated for 3 minutes.
- After the programme has finished, select Save to save the settings for the selected category and weight as a User programme (see “User programmes”).

## Special applications

### Reheating with the Microwave function

Drink/ Food	Quantity	 [W]	 [min.]	 <sup>1</sup> [min.]
Drinks (drinking temperature 60–65 °C)	1 cup/1 glass (200 ml)	1000	00:50– 1:10	–
Baby bottle (milk) <sup>2</sup>	Approx. 200 ml	450	00:50– 1:00 <sup>3</sup>	1
Food for babies and children <sup>3</sup>	1 jar (200 g)	450	00:30– 1:00	1
Sliced meat with sauce <sup>3</sup>	200 g	600	3:00–5:00	1
Side dishes <sup>3</sup>	250 g	600	3:00–5:00	1

 Microwave power level,  Cooking duration,  Standing time

- <sup>1</sup> Allow food to stand at room temperature. This allows the heat to spread evenly throughout the food.
- <sup>2</sup> Flash boiling can be avoided by stirring liquids before heating them. After heating, wait at least 20 seconds before removing the container from the oven. In addition, a glass rod or similar item, if available, can be placed in the container during heating.
- <sup>3</sup> The durations apply to food with an initial temperature of approx. 5 °C.  
For food not normally refrigerated, durations apply to food at room temperature of approx. 20 °C.  
With the exception of baby food and delicate whisked sauces, food should be heated to a temperature of 70–75 °C.

## Heat crockery

By pre-heating the crockery, the food does not cool down as quickly.

Use heat-resistant crockery.

- Place the rack on shelf level 1 and place the crockery to be pre-heated on it. Depending on the size of the crockery, you can also place it on the oven floor.
- Select Special applications .
- Select Heat crockery.
- Alter the recommended temperature if necessary and then set the duration.
- Follow the instructions in the display.



**Risk of injury caused by hot surfaces.**

The oven gets hot during operation. You could burn yourself on the heating elements, the oven compartment, or accessories. Droplets of water may have accumulated underneath the crockery.

Wear oven gloves when removing dishes from the oven.

## Prove yeast dough

This programme is designed specifically for proving yeast dough.

- Select Special applications .
- Select Prove yeast dough.
- Alter the recommended temperature if necessary and then set the duration.
- Follow the instructions in the display.

## Keeping warm

You can keep food warm in the oven compartment for several hours.

In order to maintain the quality of food, select the shortest possible time.

- Select Special applications .
- Select Keeping warm.
- Place the food to be kept warm in the oven and confirm with *OK*.
- Alter the recommended temperature if necessary and then set the duration.
- Follow the instructions in the display.

## Special applications

### Low temp. cooking

The Low temp. cooking cooking method is ideal for cooking beef, pork, veal or lamb when a tender result is desired.

First briefly sear the meat all over at a high temperature on the cooktop in order to seal it.

Then place the meat in the pre-heated oven where the low temperature and long cooking duration will cook it to perfection and ensure it is very tender.

The meat will relax. The juices inside will start to circulate evenly throughout the meat to reach the outer layers.

This gives very tender and succulent results.

- Use lean meat which has been correctly hung and trimmed. Bones should be removed before cooking.
- For searing, use a suitable cooking oil or fat that can withstand high temperatures (e.g. clarified butter, vegetable oil).
- Do not cover meat during the cooking process.

The cooking duration takes approx. 2–4 hours depending on the weight and size of the meat and how well you want it cooked.

- As soon as the cooking programme has finished, you can carve the meat straight from the oven. It does not need to rest.
- The meat can be left in the oven compartment to keep warm until you serve it. This will not affect results in any way.

- Serve on pre-heated plates with very hot sauce or gravy to prevent it cooling down too quickly. The meat is at the ideal temperature for eating straight away.

### Using the Low temp. cooking Special application

Observe the information under “Roasting – Food probe”.

- Select Special applications .
- Select Low temp. cooking.
- Follow the instructions in the display. Place the necessary accessories in the oven compartment for the pre-heating phase.
- Set the temperature and the core temperature.
- While the oven is pre-heating, sear the meat on all sides on the cooktop.

 Risk of burning due to hot surfaces!

The oven gets hot during operation. You could burn yourself on the heating elements, the oven compartment, or accessories.

Wear oven gloves when placing food in the oven or removing it, and when adjusting oven shelves etc. in a hot oven.



- As soon as Insert food probe and place food in the oven appears in the display, place the seared meat on the rack and insert the metal tip of the food probe fully into the centre of the meat.
- Close the door.

At the end of the programme, Finished appears in the display and a buzzer sounds.

### Using the Conventional Heat function

Refer to the information in the cooking charts at the end of this booklet.

Use the glass tray with the rack placed on top of it.  
Switch off the **Booster** function for the pre-heating phase.

- Place the glass tray with a rack on shelf level 1.
- Select Oven functions .
- Select the **Conventional Heat**  function and a temperature of 100 °C.
- Switch off the **Booster** function via the pull-down menu.
- Pre-heat the oven compartment together with the glass tray and the rack for approx. 10 minutes.
- While the oven is pre-heating, sear the meat on all sides on the cooktop.

 Risk of burning due to hot surfaces.

The oven gets hot during operation. You could burn yourself on the heating elements, the oven compartment, or accessories.

Wear oven gloves when placing food in the oven or removing it, and when adjusting oven shelves etc. in a hot oven.

- Place the seared meat on the oven rack.
- Reduce the temperature if necessary (see “Cooking charts”).
- Continue cooking until the end of the programme.

# Special applications

---

## Cooking

It is essential that “Warning and Safety instructions - Correct use” is observed.

Food with a thick skin or peel, such as tomatoes, sausage, potatoes and eggplants can burst when heated or cooked.

Pierce or score the skin of these types of food several times to allow steam to escape.

Eggs heated in their shells can burst, even after they have been taken out of the oven compartment.



Eggs can only be cooked in their shells in a specially designed egg-boiling device. Do not reheat hard boiled eggs using the Microwave  function.

If possible, use the food probe to monitor the temperature when cooking (see “Roasting – Food probe”).





Set the core temperature:

- Fish: at least 70 °C
- Poultry: at least 85 °C

## Useful tips

- Turn, separate or stir the food several times. Stir the food from the outside towards the middle, as food heats more quickly from the outside.
- Use only crockery that is suitable for use in a microwave and oven when using functions which use microwave power.
- If possible, use the Automatic programmes for cooking.
- Never use a lid with the MW + Fan Grill  and MW + Grill  functions, as the food will not brown.
- With the Microwave  function, select a microwave power level of 850 W to start cooking, and then continue cooking at 450 W. Observe the information in the cooking charts at the end of this book.

### Cooking with the Microwave function

<b>Soups/Casseroles Vegetables</b>	 [g]	 850 W [min.]	+	 450 W [min.]	 <sup>1</sup> [min.]
Casserole	1500	10	+	20	1
Soup	1500	11	+	24	1
Peas	500	5	+	10	2
Peas (frozen)	450	5	+	12	2
Carrots	500	5	+	10	2
Broccoli florets	500	6	+	8	2
Broccoli (frozen)	450	5	+	11	2
Cauliflower florets	500	6	+	10	2
Kohlrabi batons	500	3	+	8	2
Asparagus	500	5	+	8	2
Leeks	500	5	+	8	2
Leeks (frozen)	450	5	+	8	2
Capsicums, cut into strips	500	5	+	10	2
Beans, green	500	4	+	12	2
Brussels sprouts	500	5	+	12	2
Brussels sprouts (frozen)	450	5	+	10	2
Mixed vegetables (frozen)	450	5	+	12	2

 Weight,  Cooking duration,  Standing time

<sup>1</sup> Allow food to stand at room temperature. This allows the heat to spread evenly throughout the food.

# Special applications

## Bottling



 Risk of infection from bacteria. The spores of the botulinum bacterium are not sufficiently killed by bottling pulses and meat only once. Toxins may form which can lead to serious poisoning. These spores are only destroyed by reheating the food within 2 days after preserving. After they have cooled down, **always** reheat pulses and meat a second time within 2 days.

 Risk of injury from increased pressure in sealed tins. Preserving and heating food in sealed tins will result in an increase in pressure, which can cause them to explode. Do not use tins for preserving or heating food.

## Preparing fruit and vegetables

The instructions are for a maximum of 5 jars with a capacity of 0.5 l each.

Only use special jars for bottling:

- Fan Plus : Bottling jars with a screw cap
- Microwave : Microwave safe bottling jars with glass lids, sealed with clear adhesive tape

- Only use undamaged jars and rubber rings.
- Rinse the jars with hot water before bottling and fill them up to a maximum of 2 cm below the rim.
- After you have filled the jars with the produce, clean the glass rims with a clean cloth and hot water.
- Seal the jars with clear adhesive tape. Do not use any metal clips as they cause sparks when used with the Microwave  function.
- Insert the glass tray on shelf level 1 and place the jars on it.

### Using the Fan Plus function

- Select the Fan Plus  function and a temperature of 160–170 °C.
- Wait until bubbles evenly rise in the jars.



Reduce the temperature in time to prevent the contents from boiling over.

## Bottling fruit and gherkins

- Set the specified continued warming temperature as soon as bubbles are visible in the jars, then leave the jars in the warm oven for the time specified.

## Bottling vegetables

- As soon as bubbles are visible in the jars, set the specified bottling temperature and cook the vegetables for the time specified.
- After bottling, set the specified continued warming temperature, then leave the jars in the warm oven for the time specified.

		
Fruit	-/-	30 °C 25–35 min.
Gherkins	-/-	30 °C 25–30 min.
Beetroot	120 °C 30–40 min.	30 °C 25–30 min.
Beans (green or yellow)	120 °C 90–120 min.	30 °C 25–30 min.

 Bottling temperature and time once bubbles are visible in the jars

 Continued warming temperature and time

## Using the Microwave function

- Select the Microwave  and a microwave power level of 850 W.
- Wait until bubbles evenly rise in the jars. This takes about 3 minutes per jar. With 5 jars, therefore, it takes 15 minutes.



Reduce the microwave power level in time to prevent the contents from boiling over.

## Bottling fruit and gherkins

- Switch the oven off as soon as bubbles are visible in the jars. Then leave the jars in the warm oven compartment for the time specified.

## Bottling vegetables

- As soon as bubbles are visible in the jars, set the specified microwave power level and cook the vegetables for the time specified.
- Switch the oven off after bottling and then leave the jars in the warm oven compartment for the time specified.

		
Fruit	-/-	25–35 min.
Gherkins	-/-	25–30 min.
Beetroot	450 W 20–30 min.	25–30 min.
Beans (green or yellow)	450 W 20–30 min.	25–30 min.

 Microwave power level and bottling time, as soon as bubbles are visible

 Continued warming time

## Special applications

---

### Removing the jars after bottling

 Risk of injury caused by hot surfaces.

The jars are very hot after bottling. Wear oven gloves when removing the jars from the oven.

- Take the jars out of the oven.
- Cover the jars with a towel and leave for approx. 24 hours in a draught-free area.
- After they have cooled down, **always** reheat pulses and meat a second time within 2 days.
- Remove the fasteners from the jars and make sure all jars are closed properly when storing them.

Either boil open jars again or store them in a cool place and consume the preserved fruit or vegetables immediately.

- Check the jars during storage. If jars have opened during storage or if the screw cap is bulging and does not make a popping noise when opened, destroy the contents.

### Frozen food/Ready meals

#### Tips for cakes, pizza and baguettes

- Bake cakes, pizza and baguettes on baking paper on the rack.
- Use the lowest temperature recommended on the packaging.

#### Tips for oven chips, croquettes and similar items

- Bake these frozen products on baking paper in the glass tray.
- Use the lowest temperature recommended on the packaging.
- Turn food several times during cooking.

#### Preparing frozen food/ready meals

Handling food carefully will help protect your health.

Cakes, pizzas and chips should be cooked until golden, not dark brown.

- Select the function and temperature recommended on the manufacturer's packaging.
- Pre-heat the oven.
- Place the food in the pre-heated oven on the shelf level recommended on the packaging.
- Check the food at the end of the shortest cooking duration recommended on the packaging.



Under MyMiele  , you can save frequently used applications.

It is particularly useful with Automatic programmes as you do not need to work through every screen in order to start your programme.



**Useful tip:** You can also set menu options that you have entered into MyMiele to appear on the start screen (see “Settings – Start screen”).

## Adding entries

You can add up to 20 entries.

- Select MyMiele  .
- Select Add entry.

You can select options listed in the following categories:



- Oven functions
- Automatic programmes  **Auto**
- Special applications  
- User programmes  

- Confirm with *OK*.

The selected item and its respective symbol will appear in the list.



- Proceed as above for further entries. Only options that have not yet been selected are available for selection.

## Deleting entries

- Select MyMiele  .
- Touch the entry you want to delete and keep your finger on it until the context menu appears.
- Select Delete.

The entry will then be removed from the list.

## Moving entries

- Select MyMiele  .
- Touch the entry you want to move and keep your finger on it until the context menu appears.
- Select Move.

An orange border appears around the entry.

- Move the entry.

The entry appears in the desired position.

## User programmes

---

You can create and save up to 20 of your own programmes.

- You can combine up to 10 cooking stages to accurately programme your favourite or most frequently used recipes. In each cooking stage you can select settings such as function, temperature and duration or core temperature.
- You can specify the shelf level(s) for the food.
- You can enter the name of the programme for your recipe.

When you call up and start your programme the next time, it will run automatically.

There are different ways of creating a User programme:

- At the end of an Automatic programme, save it as a User programme.
- After running a programme with a set duration, save it.

Then name the programme.

### Creating a User programme

- Select User programmes .
- Select Create programme.

You can now specify the settings for the first cooking stage.

Follow the instructions in the display:

- Select and confirm the desired settings.

If you select the Pre-heat function, use Add to add another cooking stage where you set a cooking duration. Only then can you save or start the programme.

All settings for the first cooking stage have now been set.

You can add more cooking stages, for example, if you want to add another cooking function to follow on from the first.

- If additional cooking stages are required, select Add and proceed as for the first cooking stage.
- When you have finished setting all the cooking stages, select Set shelf level.
- Select the desired level(s).
- Confirm with *OK*.

If you want to check the settings or to change them at a later stage, touch the cooking stage in question.

- Select Save.
- Enter the programme name using the keyboard.

You can add a line break for longer programme names using the  symbol.

- Once you have entered the programme name, select Save.

A message will appear in the display confirming that the new name has been saved.

- Confirm with *OK*.

You can start the saved programme immediately, delay the start or change the cooking stages.

## Starting a User programme

- Place the food in the oven.
- Select User programmes .
- Select the required programme.

Depending on the programme settings, the following menu options will appear in the display:

- Start now  
The programme will start immediately. The oven heating will switch on immediately.
  - Finish at  
Specify the time at which the programme should finish. The oven heating will switch off automatically at the time you have set.
  - Start at  
Specify the time at which you want the programme to start. The oven heating will switch on automatically at the time you have set.
  - Display cooking stages  
A summary of your settings will appear in the display.
  - Display actions  
The required actions, e.g. placing the food in the oven, will appear in the display.
- Select the required menu option.
  - Confirm the message regarding which shelf level to use with *OK*.

The programme selected will begin straight away or at the time set.

Use  Info to display information such as how to place or turn the food depending on the cooking programme.

- At the end of the programme, select Close.

## Changing cooking stages

Cooking stages in an Automatic programme that you have renamed as a User programme cannot be changed.

- Select User programmes .
- Touch the programme you want to change and keep your finger on it until the context menu appears.
- Select Change.
- Select the cooking stage that you want to change or *Add* to add another cooking stage.
- Select and confirm the desired settings.
- If you want to start the modified programme without changing it, select *Start*.
- Select *Save* when you have changed all the settings.

A message will appear in the display confirming that the new name has been saved.

- Confirm with *OK*.

The saved programme has been changed and you can start it immediately or delay the start.

# User programmes

---

## Renaming User programmes

- Select User programmes .
- Touch the programme you want to change and keep your finger on it until the context menu appears.
- Select Rename.
- Change the programme name using the keyboard.

You can add a line break for longer programme names using the `↵` symbol.

- Once you have changed the programme name, select Save.

A message will appear in the display confirming that the new name has been saved.

- Confirm with *OK*.

The programme has now been renamed.

## Deleting User programmes

- Select User programmes .
- Touch the programme you want to delete and keep your finger on it until the context menu appears.
- Select Delete.
- Confirm the query with Yes.

The programme will be deleted.

Go to Settings | Factory default settings | User programmes to delete all User programmes at the same time.

## Moving User programmes

- Select User programmes .
- Touch the programme you want to move and keep your finger on it until the context menu appears.
- Select Move.

An orange border appears around the entry.

- Move the programme.

The programme appears in the desired position.

Handling food carefully will help protect your health.

Cakes, pizzas and chips should be cooked until golden, not dark brown.

## Tips on baking

- Set a cooking duration. When baking, the oven should not be set to start a long time off. Otherwise the cake mixture or dough will dry out, and the raising agents will lose their effectiveness.
- Avoid using bright, thin-walled tins as they give an uneven or poor browning result. In certain unfavourable conditions, the food will not cook properly.
- Place cakes in rectangular tins on the rack with the longer side across the width of the oven for optimum heat distribution and even results.
- Line the glass tray with baking paper before placing chips, potatoes croquette and similar types of food on it.

## Notes on the cooking charts

You can find the cooking charts at the end of this book.

## Selecting the temperature

- As a general rule, select the lower temperature given in the chart. Baking at temperatures higher than those recommended may reduce the cooking duration, but will lead to uneven browning of the food, and unsatisfactory cooking results.

## Selecting the cooking duration

Unless otherwise stated, the cooking durations given in the cooking charts are for an oven compartment which has not been pre-heated. With a pre-heated oven compartment, shorten durations by around 10 minutes.

- As a general rule, check whether the food is cooked after the shortest duration. Stick a wooden skewer into the food.

If it comes out clean without any batter/dough on it, the food is done.

## Notes on the oven functions

You can find an overview of all the functions with their recommended values in “Main and sub-menus”.

## Using Automatic programmes

- Follow the instructions in the display.

## Using Fan Plus

You can use any type of baking tray made of heat-resistant material.

Because the fan distributes the heat around the oven compartment straight away, it allows you to use a lower temperature than you would with the Conventional Heat  function.

Use this function if you are baking on multiple shelves at the same time.

- 1 shelf level: place cakes in baking tins on shelf level 1.
- 1 shelf level: place flat items (e.g. biscuits, tray cakes) on shelf level 2.
- 2 shelf levels: depending on the height, place the food on shelf levels 1+3 or 2+3.

# Baking

## Using Conventional Heat

Dark metal, enamel, or aluminium bakeware with a matte finish, as well as heat-resistant glass, ceramic, and coated bakeware can be used.

Use this function for baking traditional recipes. If using an older recipe or cookbook, set the oven temperature 10 °C lower than that recommended. This will not change the cooking duration.

- Place cakes in baking tins on shelf level 1.
- Place flat items (e.g. biscuits, tray cakes) on shelf level 2.

## Using Intensive Bake

You can use any type of baking tray made of heat-resistant material.

Use this function for baking cakes with moist toppings.

Do **not** use this function for baking thin biscuits.

- Place cakes in baking tins on shelf level 1.

## Using Eco Fan Heat

You can use any type of baking tray made of heat-resistant material.

Use this function for cooking bakes and gratins that need to be crispy on top.

- Place cakes or bakes in baking tins on shelf level 1.
- Place flat items (e.g. biscuits, tray cakes) on shelf level 2.

## Using MW + Fan Plus

Use heat-resistant baking tins suitable for microwave use (see “Microwave operation - Suitable containers for microwave use”), such as heat-resistant glass or ceramic dishes, as these allow microwaves through them.

The MW + Fan Plus  function is particularly suitable for baking dough which requires a longer cooking duration, such as rubbed in, beaten mixtures and yeast recipes.

If you use this function, the cooking duration is shortened.

When selecting the microwave power level, observe the information in the cooking charts and in the recipes.

- Place the glass tray on shelf level 1.
- Place the baking tin on the glass tray.

**Useful tip:** Metal tins are less suitable for functions which use microwave power because the metal reflects the microwaves. The microwaves only reach the cake from above, which extends the cooking duration. If you use metal tins, place the tin on the glass tray so that it cannot touch the oven walls. If sparks form, do not reuse the tin for functions which use microwave power.

## Tips for roasting

- **Pre-heating** the oven compartment is only required when roasting beef sirloin joints and fillet. Pre-heating is generally not necessary.
- Use a **closed roasting dish** for roasting meat, such as an oven dish. The meat stays succulent. The oven compartment will also stay cleaner than when roasting on the rack. This ensures that sufficient stock remains for making gravy.
- If you are using a **roasting bag**, follow the instructions on the packaging.
- If you are using the **rack** or an **open roasting dish** for roasting, you can add a little fat or oil to very lean meat or place a few strips of streaky bacon on the top.
- **Season** the meat and place in the roasting dish. Dot with butter or margarine or brush with oil or cooking fat if necessary. For large lean cuts of meat (2–3 kg) and fatty poultry, add about 1/8 l of water to the dish.
- Do not add too much liquid during cooking as this will hinder the **browning** process. Browning only occurs towards the end of the cooking duration. Remove the lid about halfway through the cooking duration if a more intensive browning result is desired.
- At the end of the programme, take the food out of the oven compartment, cover it and leave to **stand** for about 10 minutes. This helps retain juices when the meat is carved.
- For a crisp finish, baste **poultry** 10 minutes before the end of the cooking duration with slightly salted water.

## Notes on the cooking charts

You can find the cooking charts at the end of this book.

- Take note of the temperature range, microwave power levels, shelf levels and durations. These also take the type of cooking container, the size of the meat and cooking practices into account.

### Selecting the temperature

- As a general rule, select the lower temperature given in the chart. If higher temperatures are used than those specified, the meat will brown on the outside, but will not be properly cooked through.
- For cuts which weigh more than 3 kg, select a temperature approx. 10 °C lower than that given in the chart. The roasting process will take longer, but the meat will cook evenly through and the skin or crackling will not be too thick.
- When roasting on the rack, set a temperature approx. 20 °C lower than for roasting in a covered oven dish.

### Selecting the cooking duration

Unless otherwise stated, the durations given in the cooking chart are for an oven compartment which has not been pre-heated.

- Determine the cooking duration by multiplying the thickness of the roast [cm] with the time per cm [min./cm] stated below, depending on the type of meat:
  - Beef/Venison: 15–18 min./cm
  - Pork/Veal/Lamb: 12–15 min./cm
  - Sirloin joints/Filletts: 8–10 min./cm
- As a general rule, check whether the food is cooked after the shortest duration.

# Roasting

## Notes on the oven functions

You can find an overview of all the functions with their recommended values in “Main and sub-menus”.

Use the Bottom Heat  function towards the end of the cooking duration to brown the base of the food.



Do not use the Intensive Bake  function for roasting as the juices will become too dark.

## Using Automatic programmes

- Follow the instructions in the display.

## Using Fan Plus or Auto Roast

These functions are suitable for roasting meat, fish and poultry that needs to be well browned as well as sirloin joints and fillet.

The Fan Plus  function allows you to use a lower temperature than you would with the Conventional Heat  function, because the heat is immediately distributed around the oven compartment.

In the Auto Roast  function, the oven compartment heats initially to a high searing temperature (approx. 230 °C). As soon as this temperature has been reached, the oven automatically drops the temperature back down to the pre-selected roasting temperature (continued roasting).

- For roasting, use crockery with heat-resistant handles such as an oven dish, roasting pan, Römertopf or a heat-resistant glass dish.
- Place the rack with the food on shelf level 1.

## Using MW + Fan Plus or MW + Auto Roast

These functions are **not** suitable for roasting delicate cuts of meat such as sirloin joints or fillet. The centre would be too well cooked before the exterior is browned.

Use the MW + Fan Plus  function for rapid reheating and cooking of food while browning it at the same time. This function saves the most time and energy.

Use the MW + Auto Roast  function for searing using a high temperature to start with, then continue cooking with a lower temperature.

If you use functions which use microwave power, the cooking duration is shortened.

When selecting the microwave power level, observe the information in the cooking charts and in the recipes.

- Dishes must be suitable for use in a microwave oven, must be heat-resistant and must not have metal lids (see “Suitable containers for microwave use”).
- Place the rack together with the glass tray or the glass tray on shelf level 1.

## Food probe

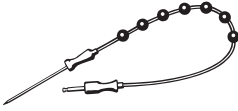

The food probe enables the temperature to be monitored precisely during a cooking programme.

### How it works

The metal tip of the food probe must be inserted into the centre of the food all the way to the handle. There is a temperature sensor in the metal tip which measures the core temperature of the food during cooking. The rise in the core temperature of the food reflects the progress of cooking. Set a lower or higher core temperature, depending on whether you want your roast to be rare, medium or well-done.

The core temperature can be set up to 99 °C. Information on food and respective core temperatures can be found in the cooking charts at the end of this book.

The cooking duration will be similar when cooking with or without the food probe.

### Options for use

Some Automatic programmes and Special applications will prompt you to use the food probe.

You can also use the food probe with User programmes and with the following functions:

- Auto Roast 
- Fan Plus 
- Conventional Heat 
- Microwave 
- MW + Auto Roast 
- MW + Fan Plus 

### Important notes on use

- You can place the meat in a pot, on the rack or in the glass tray, depending on the function selected.
- The metal tip of the food probe must be fully inserted into the centre of the food so that the temperature sensor reaches more or less to the core.
- When cooking poultry, insert the metal tip into the thickest part of the breast. You can find the thickest part of the breast by pressing the area with your thumb and index finger.
- The metal tip must not touch any bone or be inserted in areas with a lot of fat. Heavily marbled areas and bones can cause cooking to end prematurely.
- If the meat is very heavily marbled with fat, select the highest core temperature given in the cooking charts.

# Roasting

- When using aluminium foil or roasting bags, insert the food probe through the foil/bag into the centre of the food. You can also place meat inside the bag or foil with the food probe already inserted. Follow the roasting bag manufacturer's instructions.

 Risk of injury caused by hot surfaces.

The food probe can get hot. You can burn yourself on the food probe. Wear oven gloves when removing the food probe.

## Using the food probe

- Fully insert the metal tip of the food probe into the centre of the meat.

If you are cooking several pieces of meat at the same time, insert the food probe into the largest piece of meat.

- Place the food in the oven.

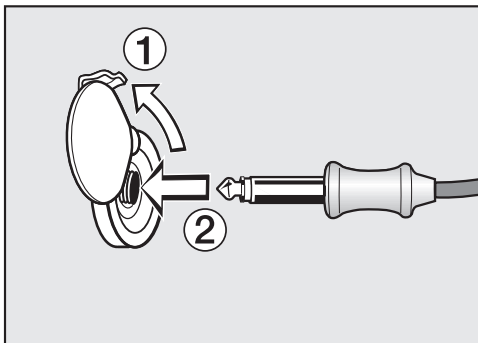

- Plug the food probe into the connection socket so that it clicks into place.
- Close the door.
- Select the oven function or Automatic programme.
- Set the temperature and the core temperature if necessary.

The core temperature cannot be changed for the Automatic programmes.  
Follow the instructions in the display.

The cooking programme finishes as soon as the core temperature is reached.

## Delaying the start of a cooking programme with food probe

You can also delay the start of the cooking programme to a later time.

- Select Start at.

You can estimate approximately when the food will be ready as the duration of the cooking programme is about the same as if you were cooking food without using the food probe.

You cannot set Duration and Finish at because the total cooking duration is determined by when the set core temperature is reached.

## Time left display

If the temperature set for a cooking process is above 140 °C, the estimated time left for the cooking process will appear in the display after a short while.

The time left is calculated from the cooking temperature selected, the set core temperature, and the progress of the core temperature as it rises.

The time left first shown is an estimate. As the cooking process continues, the time left is revised continuously, and a more accurate figure is shown.

The time left will be deleted if the cooking temperature or core temperature is changed or if a different function is selected. If the door is opened for a longer time, the time left will be recalculated.

 Risk of injury caused by hot surfaces.

If you grill with the door open, hot air will escape from the oven instead of being cooled by the cooling fan. The control elements will get hot. Grill with the oven door closed.

## Tips for grilling

- Pre-heating is necessary when grilling. For pre-heating, select a function which **does not use** microwave power. Pre-heat the top heat/grill element for approx. 5 minutes with the door closed.
- Trim the meat if necessary. Season meat 10-15 minutes before cooking.
- Add a little oil to lean meat if necessary. Do not use other types of fat as they can easily burn and cause smoke.
- Clean fish in the normal way. To enhance the flavour, season with a little salt. Fish can also be drizzled with lemon juice.
- Grill on the rack.
- To grill, brush the rack with oil and then place the food on the rack.

## Notes on the cooking charts

You can find the cooking charts at the end of this book.

- Take note of the temperature range, the shelf levels and the timings. These take the size of the meat and cooking practices into account.
- Check the food after the shortest duration quoted.

## Selecting the temperature

Select the temperature for the Fan Grill  and MW + Fan Grill  functions.

- As a general rule, select the lower temperature given in the chart. If higher temperatures are used than those specified, the meat will brown on the outside, but will not be properly cooked through.

## Selecting the grill setting

Select between setting 1–3 for the Grill  and MW + Grill  functions.

- If you are grilling thicker foods further away from the grill element, select **Setting 1**.
- If you desire a lighter, golden finish, on gratins for example, select **Setting 2**.
- If you are quickly grilling thinner foods closer to the grill element, select **Setting 3**.

# Grilling

## Selecting the cooking duration

- Grill thinner cuts of meat/slices of fish for approx. 6–8 minutes per side. It is best to grill food of a similar thickness at the same time so that the cooking durations do not vary too much.
  - Grill thicker pieces for about 7–9 minutes per side.
  - When grilling rolled meat, allow approx. 10 minutes per cm diameter.
  - As a general rule, check whether the food is cooked after the shortest duration.
  - To **test the food**, press down on the meat with a spoon. This lets you determine how well the meat has been cooked.
- **Rare**  
If the meat gives easily to the pressure of the spoon, it will still be red on the inside.
  - **Medium**  
If there is some resistance, the inside will be pink.
  - **Well-done**  
If there is great resistance, it is cooked through.

**Useful tip:** If the surface of a thicker cut of meat is browned but the centre is still raw, move the food to a lower level or reduce the temperature and continue grilling. This will stop the surface from becoming excessively charred.

## Notes on the oven functions

You can find an overview of all the functions with their recommended values in “Main and sub-menus”.

The plastic on the food probe can melt at very high temperatures.

Do not use the food probe when using the Grill functions.

Do not store the food probe in the oven compartment when it is not being used.

If you use functions which use microwave power, the cooking duration is shortened.

When selecting the microwave power level, observe the information in the grilling chart and in the recipes.

## Using Fan Grill or MW + Fan Grill

These functions are suitable for grilling thicker food, such as chicken.

A temperature setting of 220 °C is generally recommended for thinner types of food, while 180–200 °C is recommended for thicker cuts.



- Place the rack on shelf level 1 or 2 depending on the height of the food.

## Using Grill or MW + Grill



These functions are suitable for grilling thin cuts of meat and browning food.



- Place the rack on shelf level 2 or 3 depending on the height of the food.

## Fan Grill

- Use the Fan Grill  function for meat, fish, poultry and vegetables.
- Always pre-heat for at least 5 minutes before Fan Grilling.
- It is not necessary to turn food when Fan Grilling. Only one side of the food, however, will become brown.
- The door must be closed when using Fan Grill .
- When using red meat, pat the meat dry before Fan Grilling as this encourages a richer colour.
- **Ovens with the Crisp function:** Activate the Crisp function (moisture reduction) at the beginning of the Fan Grill  function. This is great for items that are moist on the inside and should be crispy on the outside.

All temperatures and shelf levels are approximations and must be varied according to the thickness and preparation of the meat. The chart below is a suggested guide only. Personal taste and size of serves will vary times and temperatures. We recommend you monitor cooking results for best outcomes.

Food to be grilled	 [°C]	 <sub>1</sub>	 [min.]
Lean thin sausages	180	3	8–10
Thick sausages	180	3	15–20
Lean beef fillet steak	220	3	6–12
Chicken breast fillet	200	3	14–18
Whole butterflied chicken	200	1	30–35
Thin white fish fillets	220	3	6–10
Thick fish fillets, cutlets or steaks	200	3	10–15
Oily fish	200	3	8–12
Lamb loin chops	190	3	12–16
Lamb back straps	220	3	8–10
Vegetables, capsicum, zucchini, sweet potato, eggplant	200	3	12–15
Potato wedges or small roast potatoes	220	2	20–25
Kebabs and satays (red meat)	200	3	12–15
Chicken satays	200	3	12–15

 Temperature / <sub>1</sub> Shelf level /  Duration

# Grilling

---

Fan Grill  can be used for small roasts but is only recommended for lean, tender cuts of meat, e.g. lamb racks, rump roasts, and beef fillet. Fan grill the roast at 200 °C on shelf level 2 for approximately 25 minutes, depending on thickness.

## Grill

- Use for thick toasts, muffins, cheese on toast, focaccia, bruschetta and bacon.
- Pre-heat grill for at least 5 minutes at 200–220 °C.
- Select the appropriate shelf level for the thickness of the food.
- The door must be closed when using the Grill  function.

This is a suggested guide only. Personal taste and size of serves will vary times and temperatures.

 Risk of injury caused by hot surfaces.

The oven gets hot during operation. You could burn yourself on the heating elements, the oven compartment, or accessories. Allow the heating elements, oven compartment and the accessories to cool before manual cleaning.

 Risk of injury due to electric shock.

The steam from a steam cleaning appliance could reach electrical components and cause a short circuit. Do not use a steam cleaner to clean the oven.

The use of unsuitable cleaning agents can cause the surfaces to discolour or alter. The oven front is particularly susceptible to damage from oven cleaners.

All surfaces of this appliance are susceptible to scratching. Scratches on glass surfaces could cause a breakage in certain circumstances. Remove all cleaning agent residues immediately.

Stubborn soiling could damage the oven in certain circumstances.

Once the oven has cooled, clean the oven compartment, the inside of the door and the door seal. Waiting too long can make cleaning unnecessarily difficult and in some cases impossible.

Operating a damaged oven can result in microwave leakage and present a hazard to the user.

Check the door and door seal for any sign of damage. If any damage is noticed, the oven should not be used again with microwave functions until the fault has been rectified by a service technician.

Cosmetic products, especially sunscreen, and hand disinfectants can leave stains on matt glass surfaces.

If cosmetic products come into contact with a matt glass surface, remove the residue immediately with hot water, washing-up liquid and a clean microfibre cloth.

## Unsuitable cleaning agents

To avoid damaging the surfaces of your appliance, do not use:

- cleaning agents containing soda, alkalines, ammonia, acids or chlorides
- cleaning agents containing descaling agents on the front
- abrasive cleaning agents, e.g. powder cleaners and cream cleaners
- solvent-based cleaning agents
- stainless steel cleaning agents
- dishwasher cleaners
- glass cleaning agents
- cleaning agents for ceramic cooktops
- hard, abrasive brushes or sponges, e.g. pot scourers, brushes or sponges which have been previously used with abrasive cleaning agents
- dirt eraser sponges
- sharp metal scrapers

## Cleaning and care

---

- steel wool or metal scourers
- spot cleaning with mechanical cleaning agents
- Oven cleaners \*
- stainless-steel spiral pads

\* These can, however, be used to remove very heavy soiling from PerfectClean treated surfaces

If soiling is left on for any length of time, it may become impossible to remove. Continued use without regular cleaning will make the oven much harder to clean. Failure to maintain the oven in a clean condition could lead to deterioration of the surfaces that could adversely affect the life of the appliance and result in a hazardous situation. Remove any soiling immediately.

Only the glass tray is dishwasher proof.

**Useful tip:** Soiling caused by spilled fruit juices and cake mixtures is best removed while the oven is still warm. Exercise caution and make sure the oven is not too hot.

To make it easier to clean the oven:

- Lower the top heat/grill element.
- To neutralise odours in the oven compartment, put a container of water with some lemon juice in the oven and heat for a few minutes.

### Removing normal soiling

Moisture inside the oven can cause damage.

Do not use too much water on the cloth or sponge and do not let water or any other substance find its way into any openings.

### Removing normal soiling

- It is best to remove normal soiling immediately using a clean sponge and a solution of hot water and washing-up liquid, or a clean, damp microfibre cloth.
- Remove any residual cleaning agent thoroughly with clean water. This is particularly important for any parts with a PerfectClean finish, as cleaning agent residues will impair the non-stick properties.
- After cleaning, wipe the surfaces dry using a soft cloth.

### Cleaning the food probe

Do not put the food probe into water or clean it in the dishwasher as this will damage it.

Clean the food probe with a damp cloth only.

### Removing stubborn soiling

Spilt fruit and roasting juices may cause lasting discolouration or matte patches on surfaces. This discolouration will not affect the functional characteristics of the surface finish.

Do not attempt to remove these marks. Clean them following the instructions given here.

- Moisten stubborn soiling with a solution of hot water and washing-up liquid and leave to soak for a few minutes.
- If necessary, the scouring pad on the back of a non-scratching washing-up sponge can be used to remove the soiling after the soaking time.

### Using oven cleaners

- Very stubborn soiling on PerfectClean surfaces can be cleaned using Miele Oven Cleaner. This cleaner must only be applied to cold surfaces.

If the oven spray gets into gaps and openings, a strong odour is generated during subsequent cooking programmes.

Do not spray the oven cleaner onto the roof of the oven compartment.

Do not spray the oven cleaner into the gaps and openings of the oven compartment walls and rear wall.

- Follow the instructions on the packaging.

Oven cleaners from other manufacturers must only be used in a cold oven and must not be left on for longer than 10 minutes.

- If necessary, the scouring pad on the back of a non-scratching washing-up sponge can be used to remove the soiling after the soaking time.
- Remove any residual cleaning agent thoroughly with clean water.
- Dry all surfaces with a soft cloth.

## Cleaning and care

### Lowering the top heat/grill element

If the oven compartment roof is badly soiled, the top heat/grill element can be lowered to make cleaning easier. Clean the oven compartment roof regularly with a damp cloth or a dishwashing sponge.

 Risk of injury caused by hot surfaces.

The oven gets hot during operation. You could burn yourself on the heating elements, the oven compartment, or accessories.

Allow the heating elements, oven compartment and the accessories to cool before manual cleaning.

The oven compartment floor can be scratched by the falling nut. Place a cloth or similar item over the oven compartment floor to protect it.

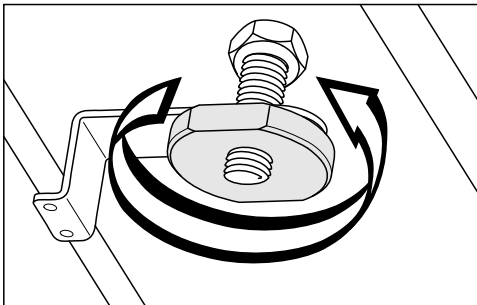

- Undo the nut.

Use caution not to damage the top heat/grill element.

Do not use force to lower the top heat/grill element as this can cause it to break.

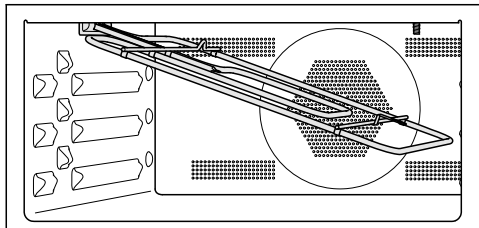

- Carefully lower the top heat/grill element.

The mica sheet can be damaged on the top of the oven cavity.

Do not use the abrasive side of the dishwashing sponge to clean the roof liner.

The LED on the oven compartment roof can be damaged.

Do not clean the LED if possible.

- Clean the roof of the oven with a damp cloth or a soft dishwashing sponge.
- After cleaning, raise the top heat/grill element gently back up again.
- Replace the nut and tighten it securely.

## Problem solving guide



Many malfunctions and minor faults that can occur in daily operation can be corrected without contacting Miele. This will save you time and money because you will not need a service call.

You can find information on how to remedy faults yourself at [www.miele.com.au/service](http://www.miele.com.au/service) or [www.miele.co.nz/service](http://www.miele.co.nz/service) and on the Miele website.





Please note, however, that a call-out charge will be applied to unnecessary service visits where the problem could have been rectified as described in these operating instructions.

<b>Problem</b>	<b>Possible cause and remedy</b>
<b>The display is dark.</b>	You have selected the Time   Display   Off setting. When the oven is switched off, the display is dark. ■ As soon as the oven is switched on, the main menu will appear. If you want the time of day to be displayed constantly, select the Time   Display   On setting.
	There is no power to the oven. ■ Check that the oven plug is correctly inserted into the socket and switched on. ■ Check if the circuit breaker has tripped. Contact a qualified electrician or Miele.
<b>The signal tone does not sound.</b>	The buzzers are deactivated or set at too low a volume. ■ Switch on the buzzers or increase the volume with Settings   Volume   Buzzer tones.
<b>The oven does not heat up.</b>	Demo mode is active. You can select menu options in the display and the sensors, but the oven heating does not work. ■ Deactivate Demo mode by selecting Settings   Showroom programme   Demo mode   Off.



## Problem solving guide

Problem	Possible cause and remedy
<b>You cannot open the door with the  sensor.</b>	<p>You have selected the Display   QuickTouch   Off setting. The  sensor does not respond when the oven is switched off.</p> <ul style="list-style-type: none"><li>■ As soon as the oven is switched on, the sensors will respond. If you want the sensors to respond even when the oven is switched off, select the Display   QuickTouch   On setting.</li></ul>
	<p>The oven is not connected to the power supply.</p> <ul style="list-style-type: none"><li>■ Make sure that the plug is correctly inserted in the socket and that the socket switch has been switched to on.</li><li>■ Check if the circuit breaker has tripped. Contact a qualified electrician or Miele.</li><li>■ If you need to open the door, for instance because there is still food in the oven compartment, use the opener supplied to prise the door open. To do so, push the opener at an angle into the gap on the outside edge of the door at the top between the control panel and the door. You can also pull the door open by grasping the sides of the door with both hands and pulling carefully until it opens.</li></ul>
<b>You cannot start a cooking programme.</b>	<p>If you are cooking with microwave power, the door may be open.</p> <ul style="list-style-type: none"><li>■ Check whether the door is closed properly.</li></ul>
	<p>If you are cooking with microwave power, the power level or duration is not selected.</p> <ul style="list-style-type: none"><li>■ Check whether a microwave power level and a duration have been selected.</li></ul>
	<p>If you are cooking with a function which uses microwave power, not all of the required settings have been entered.</p> <ul style="list-style-type: none"><li>■ Check whether you have entered a microwave power level, a duration and a temperature.</li></ul>

## Problem solving guide

Problem	Possible cause and remedy
<p><b>The sensor controls or the proximity sensor do not respond.</b></p>	<p>You have selected the <b>Display   QuickTouch   Off</b> setting. When this is activated, the sensor controls and proximity sensor do not respond when the oven is switched off.</p> <ul style="list-style-type: none"> <li>■ As soon as the oven is switched on, the sensor controls and the proximity sensor will respond. If you want the sensor controls and the proximity sensor to respond even when the oven is switched off, select the <b>Display   QuickTouch   On</b> setting.</li> </ul> <p>The settings for the proximity sensor are switched off.</p> <ul style="list-style-type: none"> <li>■ Change the settings for the proximity sensor by selecting <b>Settings   Proximity sensor</b>.</li> </ul> <p>The proximity sensor is defective.</p> <ul style="list-style-type: none"> <li>■ Call Miele.</li> </ul> <p>The oven is not connected to the electricity supply.</p> <ul style="list-style-type: none"> <li>■ Make sure that the plug is correctly inserted in the socket and that the socket is switched on.</li> <li>■ Check if the circuit breaker has tripped. Contact a qualified electrician or Miele.</li> </ul> <p>If the display does not respond, there is a fault with the controls.</p> <ul style="list-style-type: none"> <li>■ Touch and hold the <b>On/Off</b>  sensor until the display switches off and the oven restarts.</li> </ul>
<p><b>System lock  appears in the display when the oven is switched on.</b></p>	<p>The system lock  has been switched on.</p> <ul style="list-style-type: none"> <li>■ You can deactivate the system lock for a cooking programme by touching the  symbol for at least 6 seconds.</li> <li>■ If you want to permanently deactivate the system lock, select the <b>Safety   System lock    Off</b> setting.</li> </ul>
<p><b>Power cut -process cancelled appears in the display.</b></p>	<p>There has been a brief power cut. This has caused the current cooking programme to stop.</p> <ul style="list-style-type: none"> <li>■ Switch the oven off and then back on again.</li> <li>■ Restart the cooking programme.</li> </ul>
<p><b>12:00 appears in the display.</b></p>	<p>The power supply was interrupted for longer than 150 hours.</p> <ul style="list-style-type: none"> <li>■ Reset the time and date.</li> </ul>

## Problem solving guide

Problem	Possible cause and remedy
Maximum operating hours reached <b>appears in the display.</b>	<p>The oven has been operating for an unusually long time. This has triggered the safety switch-off function.</p> <ul style="list-style-type: none"> <li>■ Confirm with <i>OK</i>.</li> </ul> <p>The oven is now ready to use.</p>
Fault <b>and a fault code not listed here appears in the display.</b>	<p>A fault has occurred that you cannot resolve.</p> <ul style="list-style-type: none"> <li>■ Call Miele.</li> </ul>
<b>If the door is opened while cooking with the Microwave  function, the oven stops making noise.</b>	<p>This is not a fault. If the door is opened while cooking with the Microwave  function, the door contact switch will switch off microwave power and switch the cooling fan to a lower speed.</p>
<b>A noise can be heard after a cooking process.</b>	<p>The cooling fan remains switched on after a cooking programme (see “Settings – Cooling fan run-on”).</p>
<b>An abnormal sound can be heard when the oven is operating in microwave mode.</b>	<p>A metal dish has been used during a cooking programme using microwave power.</p> <ul style="list-style-type: none"> <li>■ Check if there are sparks caused by using metal dishes (see “Microwave operation - Suitable containers for microwave use”).</li> </ul>
	<p>The food was covered with aluminium foil during a programme with microwave power.</p> <ul style="list-style-type: none"> <li>■ If it is, remove the foil.</li> </ul>
	<p>The rack was used during a programme with microwave power.</p> <ul style="list-style-type: none"> <li>■ Always use the glass tray when using the oven with microwave power.</li> </ul>
<b>The oven has switched itself off.</b>	<p>The oven will switch itself off automatically to save energy if no other action is taken within a certain time frame after switching it on or after the end of a cooking programme.</p> <ul style="list-style-type: none"> <li>■ Switch the oven back on.</li> </ul>

## Problem solving guide

Problem	Possible cause and remedy
<p><b>Cakes and biscuits are not cooked properly after the duration given in the cooking chart.</b></p>	<p>A different temperature from the one given in the recipe has been used.</p> <ul style="list-style-type: none"> <li>■ Select the temperature required for the recipe.</li> </ul>
	<p>The ingredient quantities used are different from those given in the recipe.</p> <ul style="list-style-type: none"> <li>■ Check whether you have amended the recipe. The addition of more liquid or more eggs makes a moister mix which would take longer to cook.</li> </ul>
<p><b>The browning of baked goods is uneven.</b></p>	<p>The wrong temperature or shelf level was selected.</p> <ul style="list-style-type: none"> <li>■ There will always be a slight unevenness in browning. If browning is very uneven, check whether the correct temperature and shelf level were selected.</li> </ul>
	<p>The material or colour of the baking tin is not suitable for the oven function. Light-coloured, shiny or thin-walled tins are less suitable. These reflect the oven's heat, which means that the heat does not penetrate to the food effectively, resulting in uneven or poor browning.</p> <ul style="list-style-type: none"> <li>■ Dark, matte tins are best for baking.</li> </ul>
<p><b>The food is not sufficiently heated or is not cooked at the end of a set duration when using the Microwave  function.</b></p>	<p>Check whether the programme using microwave power has been interrupted and has not been restarted.</p> <ul style="list-style-type: none"> <li>■ Restart the cooking programme to ensure the food is heated or cooked properly.</li> </ul>
	<p>When cooking or reheating with microwave power, the time set was too short.</p> <ul style="list-style-type: none"> <li>■ Check that the correct duration is selected for the microwave power level. The lower the microwave power level, the longer the cooking duration.</li> </ul>

## Problem solving guide

Problem	Possible cause and remedy
<p><b>Food has cooled down too quickly after being reheated or cooked using microwave power.</b></p>	<p>In the microwave oven, food begins to cook from the outside first, the inside of the food relying on the slower conduction of heat. If food is cooked at a high microwave power level, it is possible that the heat may not have reached the centre of the food, so it is hot on the outside but cold in the centre. During the standing time, the heat is transferred to the centre of the food.</p> <ul style="list-style-type: none"> <li>■ When reheating food with different densities, such as with menu cooking, it is sensible to start with a low microwave power level and select a longer reheating duration.</li> </ul>
<p><b>The oven lighting switches off after a short time.</b></p>	<p>You have selected the Lighting   "On" for 15 seconds setting.</p> <ul style="list-style-type: none"> <li>■ If you want the oven lighting to remain switched on during the entire cooking programme, select the Lighting   On setting.</li> </ul>
<p><b>The oven lighting is off or does not switch on.</b></p>	<p>You have selected the Lighting   Off setting.</p> <ul style="list-style-type: none"> <li>■ Select the  sensor control to switch on the oven interior lighting for 15 seconds.</li> <li>■ If required, select the Lighting   On or "On" for 15 seconds setting.</li> </ul>
	<p>The oven interior lighting is faulty.</p> <ul style="list-style-type: none"> <li>■ Call Miele.</li> </ul>

You can find information on how to remedy faults yourself and about Miele spare parts at [www.miele.com.au/service](http://www.miele.com.au/service) or [www.miele.co.nz/service](http://www.miele.co.nz/service).

## Contact in case of fault

In the event of any faults which you cannot remedy yourself, please contact Miele.

You can book a Miele customer service call-out online at [www.miele.com.au/service](http://www.miele.com.au/service) or [www.miele.co.nz/service](http://www.miele.co.nz/service).

Contact information for Miele can be found at the end of this booklet.

Please quote the model and serial number of your appliance when contacting Miele. This information can be found on the data plate.

This information is given on the data plate, visible on the front frame of the oven, with the door fully open.

## Warranty

The manufacturer's warranty for this appliance is 2 years.

For further information, please refer to your warranty booklet.

# Installation

## Building-in dimensions

Dimensions are given in mm.

### Installation in a tall or base unit

When building the oven into a base unit underneath a cooktop, please also observe the installation instructions for the cooktop as well as the building-in height required for the cooktop.

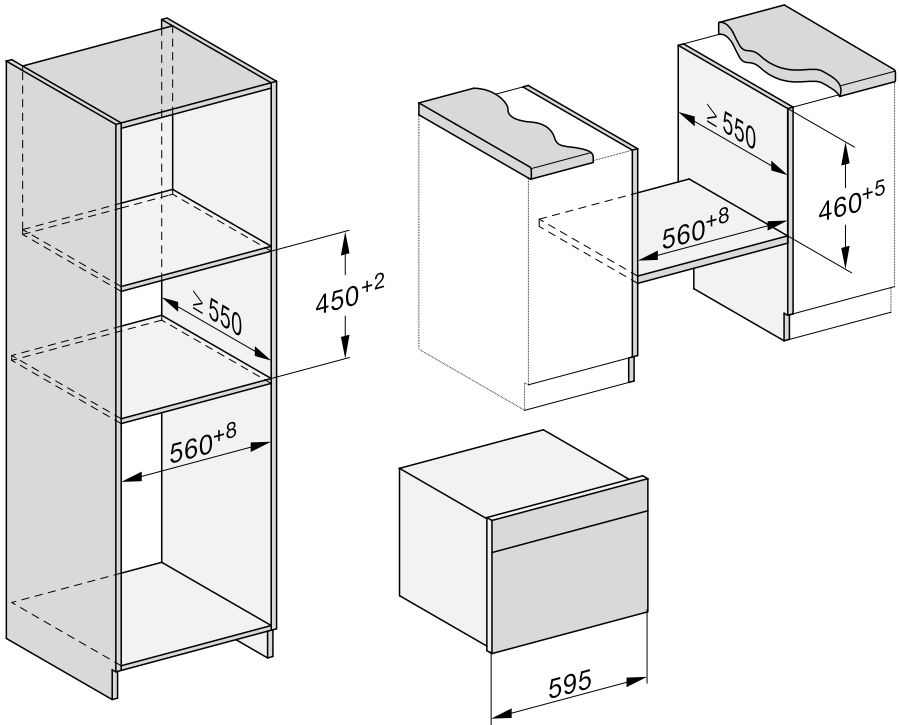

## Side view

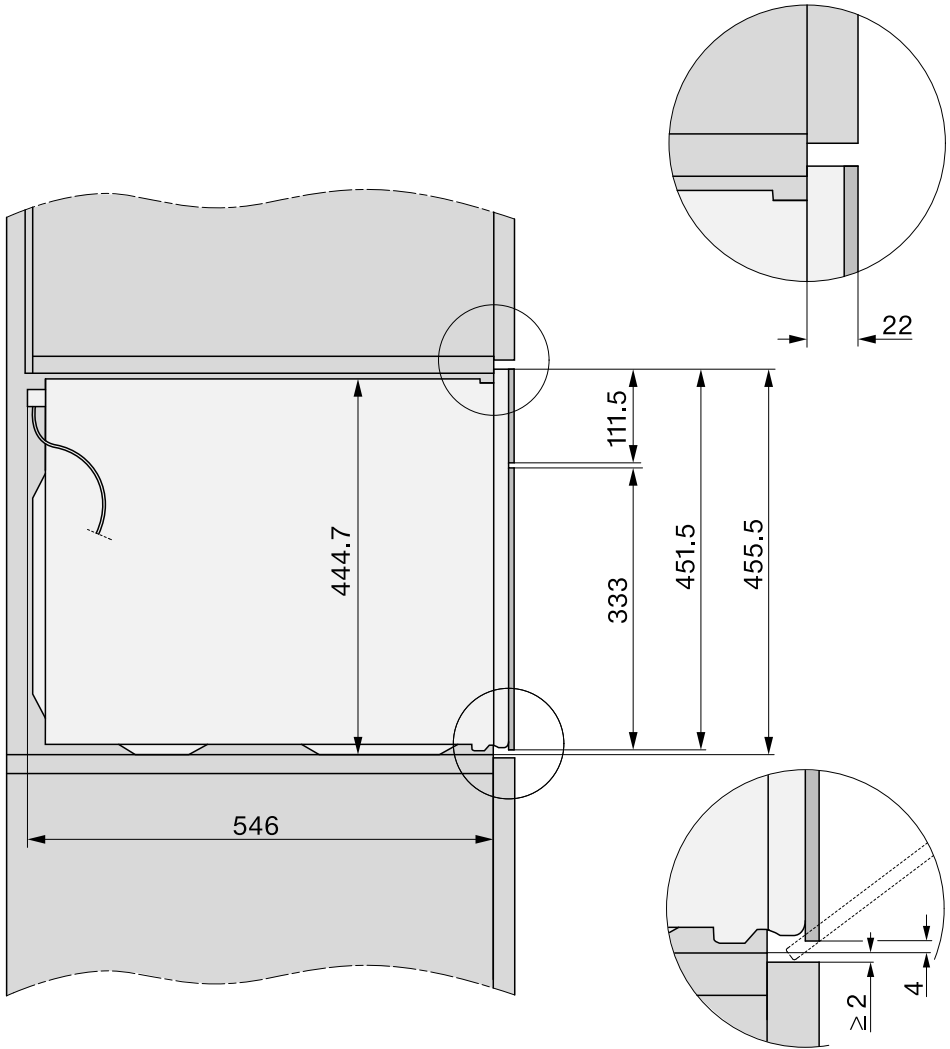

# Installation

## Connections and ventilation

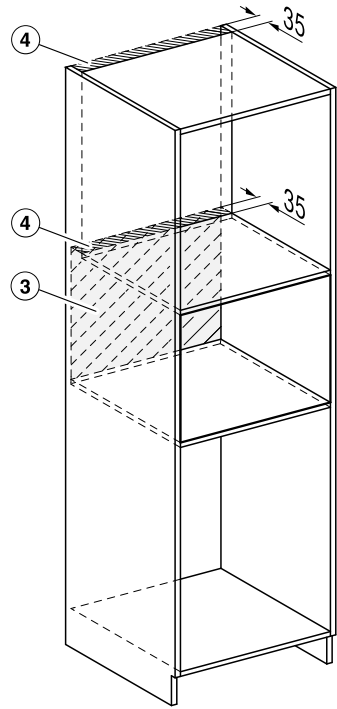
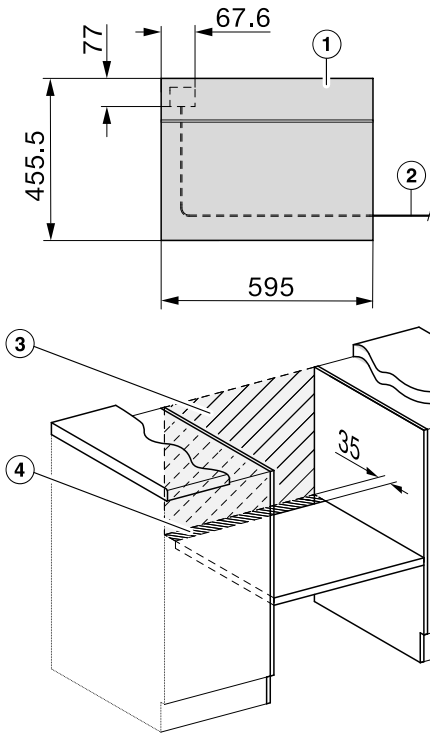

- ① Front view
- ② Mains connection cable, length = 2000 mm
- ③ No connections permitted in this area
- ④ Ventilation cut-out, min. 150 cm<sup>2</sup>

## Installing the oven

- Connect the mains cable from the oven to the electricity supply.
- Push the oven into the housing unit and align it.
- Reconnect the power supply to the mains socket.

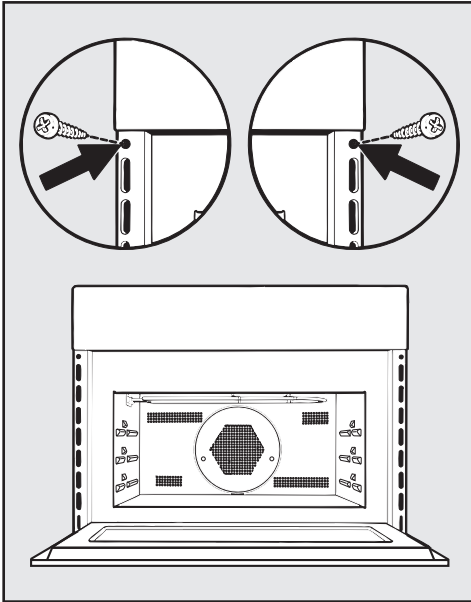

- Open the door with the  sensor and use the screws supplied to secure the oven to the side walls of the housing unit through the holes in the oven trim.

# Installation

---

## Electrical connection

The oven is equipped with a mains connection cable and plug for connection to a 50 Hz, 230 V supply. The fuse rating must be at least 16 A.

The appliance must only be connected to a correctly installed earthed socket. All electrical work must be carried out by a suitably qualified and competent person in strict accordance with national and local safety regulations.

Ensure that the plug and switch are accessible at all times.

If the appliance is hardwired or if the switch is not accessible after installation, an additional means of disconnection must be provided.

Suitable means of disconnection include accessible switches with an all-pole contact gap of at least 3 mm. These include circuit breakers, fuses and contactors.

**Voltage, rated load and fuse rating** are given on the data plate situated at the front of the oven compartment. Please ensure the connection data matches the household supply.

When contacting Miele, please quote the following:

- Model number
- Serial number
- Connection data (voltage/frequency/maximum rated load)

If the mains connection cable is damaged, a new one must be fitted by a service technician authorised by Miele.

This speed oven complies with European Standard EN 55011. This appliance is classified as a Group 2, class B product.

























Group 2 appliances use high frequency energy in the form of electromagnetic waves to create heat in food.









Class B is assigned to appliances that are suitable for domestic use.

Temporary or permanent operation with a self-sufficient or non-mains synchronous energy supply system (e.g. isolated networks, back-up systems) is possible. A requirement for the operation is that the energy supply system complies with all current local and national requirements that apply to stand-alone, solar and/or battery systems.

The protective measures provided in the domestic installation and in this Miele product must also be assured in their function and operation in isolated operation or in non-mains synchronous operation, or replaced with equivalent measures in the installation.

## Creamed mixture

Cakes/Biscuits (accessories)		 +  [°C] + [W]		 <sup>3</sup> <sub>1</sub>	 [min.]	CF
Muffins		150–160	✓	2	35–45	–
		160–170	✓	2	35–45	–
Small cakes (1 glass tray)		150	–	2	25–35	–
		170 <sup>2</sup>	–	2	20–30	–
Small cakes (2 glass trays)		140	–	2+3	35–45	–
Sand cake (loaf tin, 30 cm)	 <sup>1</sup>	160–170 + 80	✓	1	35–45	–
		150–160	–	1	60–70	–
Ring cake (ring tin/Gugelhupf cake tin, Ø 26 cm)	 <sup>1</sup>	160–170 + 150	✓	1	40–50	–
Marble, nut cake (loaf tin, 30 cm)		150–160	✓	1	65–75	–
		150–160	✓	1	65–75	–
Marble, nut cake (ring tin/Bundt cake tin, Ø 26 cm)		150–160	✓	1	55–65	–
		150–160	✓	1	65–75	–
Fresh fruit cake (1 glass tray)		150–160	✓	2	50–60	–
		160–170	–	2	55–65	–
Fresh fruit cake (springform cake tin, Ø 26 cm)		150–160	✓	1	55–65	–
		165–175 <sup>2</sup>	–	1	50–60	–
Flan base (flan base tin, Ø 28 cm)		150–160	✓	1	25–35	–
		170–180 <sup>2</sup>	✓	1	15–25	–























 Function,  Temperature,  Microwave power level,  Booster, <sup>3</sup><sub>1</sub> Shelf level,  
 Cooking duration, CF Crisp function,  Fan Plus,  Conventional Heat,  MW + Fan Plus, ✓ On, – Off









<sup>1</sup> Place the baking tin in the centre of the glass tray.

<sup>2</sup> Pre-heat the oven before placing the food inside.

# Cooking charts

## Rubbed in mixture



















Cakes/Biscuits (accessories)		 [°C]		 <sup>3</sup> <sub>1</sub>	 [min.]	CF
Biscuits (1 glass tray)		140–150	✓	2	20–30	–
		160–170	✓	2	10–20	–
Drop cookies (1 glass tray)		140	–	2	40–50	–
		160 <sup>1</sup>	–	2	30–40	–
Drop cookies (2 glass trays)		140	–	2+3	45–55 <sup>2</sup>	–
Flan base (flan base tin, Ø 28 cm)		150–160	✓	2	30–40	–
		170–180 <sup>1</sup>	✓	1	20–30	–
Cheesecake (springform cake tin, Ø 26 cm)		160–170	–	1	90–100	–
		150–160	–	1	80–90	–
Apple cake (springform cake tin, Ø 20 cm)		160	–	1	110–120	–
		180	–	1	80–90	–
Apple pie (springform cake tin, Ø 26 cm)		160–170	✓	1	55–65	–
		150–160	✓	1	60–70	–
Fresh fruit cake (springform cake tin, Ø 26 cm)		160–170	✓	1	55–65	–
		150–160	✓	1	60–70	–
Fresh fruit cake, glazed (1 glass tray)		160–170	✓	2	50–60	–
Swiss flan (1 glass tray)		230–240 <sup>1</sup>	–	1	40–50	✓









 Function,  Temperature,  Booster, <sup>3</sup><sub>1</sub> Shelf level,  Cooking duration, CF Crisp function,  Fan Plus,  Conventional Heat,  Intensive Bake, ✓ On, – Off

<sup>1</sup> Pre-heat the oven before placing the food inside.

<sup>2</sup> Take the baking trays out of the oven early if the food has already browned sufficiently before the specified cooking time has elapsed.









## Yeast dough







Cakes/Biscuits (accessories)		 +  [°C] + [W]		 <sup>3</sup> <sub>1</sub>	 [min.]	CF
Bundt cake (Bundt cake tin, Ø 24 cm)		140–150	✓	1	55–65	–
		150–160	✓	1	60–70	–
Stollen (1 glass tray)		150–160	✓	1	60–70	–
		160–170	✓	1	55–65	–
Streusel cake with/without fruit (1 glass tray)		160–170	✓	2	40–50	–
		170–180 + 150	–	2	30–40	–
Fresh fruit cake (1 glass tray)		160–170	✓	2	40–50	–
		170–180 + 150	–	2	25–35	–
Apple turnovers/Raisin scrolls (1 glass tray)		160–170 <sup>1</sup>	✓	2	20–30	–
White bread (free form) (1 glass tray)		180–190	–	2	35–45	–
White bread (loaf tin, 30 cm)		190–200	✓	1	50–60	–
Wholegrain bread (loaf tin, 30 cm)		180–190	✓	1	40–50	–
Prove yeast dough (bowl)		30	–	1	30	–

 Function,  Temperature,  Booster, <sup>3</sup><sub>1</sub> Shelf level,  Cooking duration, CF Crisp function,  Fan Plus,  Conventional Heat,  MW + Fan Plus, ✓ On, – Off

<sup>1</sup> Pre-heat the oven before placing the food inside.











## Quark dough









Cakes/Biscuits (accessories)		 +  [°C] + [W]		 <sup>3</sup> <sub>1</sub>	 [min.]	CF
Fresh fruit cake (1 glass tray)		160–170	✓	2	40–50	–
		170–180 + 150	–	2	25–35	–
Apple turnovers/Raisin scrolls (1 glass tray)		160–170	✓	2	20–30	–

 Function,  Temperature,  Booster, <sup>3</sup><sub>1</sub> Shelf level,  Cooking duration, CF Crisp function,  Fan Plus,  MW + Fan Plus, ✓ On, – Off

# Cooking charts

## Sponge mixture













Cakes/Biscuits (accessories)		 [°C]		 <sup>3</sup> <sub>1</sub>	 [min.]	CF
Sponge cake base (2 eggs, springform cake tin, Ø 26 cm)		170–180 <sup>2</sup>	–	1	15–25	–
Sponge cake base (4 eggs, springform cake tin, Ø 26 cm)		170–180 <sup>2</sup>	–	1	25–35	–
Whisked sponge (springform cake tin, Ø 26 cm)		180–190 <sup>2</sup>	–	2	20–30	–
	 <sup>1</sup>	150–180 <sup>2</sup>	–	1	20–45	–
Swiss roll sponge (1 glass tray)		170–180 <sup>2</sup>	–	2	15–25	–









 Function,  Temperature,  Booster,  <sup>3</sup><sub>1</sub> Shelf level,  Cooking duration, CF Crisp function,  Conventional Heat,  Fan Plus,  On, – Off

<sup>1</sup> In general, if a range of temperatures is given, it is best to select the lower temperature and to check the food after the shortest time.

<sup>2</sup> Pre-heat the oven before placing the food inside.

## Choux pastry, puff pastry, meringue

Cakes/Biscuits (accessories)		 [°C]		 <sup>3</sup> <sub>1</sub>	 [min.]	CF
Choux buns (1 glass tray)		160–170		2	30–40	–
Pastry puffs (1 glass tray)		170–180 <sup>1</sup>		2	15–25	–
Macaroons (1 glass tray)		120–130 <sup>1</sup>		2	28–38	–
Meringues/Pavlovas (1 glass tray, 1 tray of 6 Ø 6 cm)		80–100	–	2	120–150	–

 Function,  Temperature,  Booster,  <sup>3</sup><sub>1</sub> Shelf level,  Cooking duration, CF Crisp function,  Fan Plus,  Conventional Heat,  On, – Off

<sup>1</sup> Pre-heat the oven before placing the food inside.

## Savoury snacks

















Food (accessories)		+ [°C] + [W]		<sup>3</sup> <sub>1</sub>	 [min.]	CF
Savoury flan (1 glass tray)		240–250 <sup>2</sup>	✓	1	35–45	✓
Onion tart (1 glass tray)		180–190 + 150	–	2	30–40	–
		150–160	✓	1	30–40	–
Pizza, yeast dough (1 glass tray)		160–170 + 80	–	2	25–35	–
		180–190 <sup>2</sup>	✓	2	30–40	✓
Pizza, quark dough (1 glass tray)		150–160	–	2	25–35	–
		190–200 <sup>2</sup>	✓	2	30–40	✓
Toast (rack)	<sup>1</sup>	3 <sup>3</sup>	–	2	2–4	–
Baked dishes/gratins (e.g. toast) (rack on the glass tray)	<sup>1</sup>	3	–	2	5–9	–
Grilled vegetables (rack on the glass tray)	<sup>1</sup>	3 <sup>3</sup>	–	2	10–12 <sup>4</sup>	–
		210–220 <sup>3</sup>	–	2	8–10 <sup>4</sup>	–











Function, Temperature, Booster, <sup>3</sup><sub>1</sub> Shelf level, Cooking duration, CF Crisp function, Conventional Heat, MW + Fan Plus, Intensive Bake, Fan Plus, Grill, Fan Grill, ✓ On, – Off

- <sup>1</sup> Select the specified grill setting.
- <sup>2</sup> Pre-heat the oven before placing the food inside.
- <sup>3</sup> Pre-heat the oven for 5 minutes before placing the food inside.
- <sup>4</sup> Turn the food halfway through cooking.

# Cooking charts

## Beef

Food (accessories)		 [°C]		 3 1	 [min.]	 [°C]
Braised beef, approx. 1 kg (oven dish with lid)	 <sup>2</sup>	150–160	✓	1	120–130 <sup>6</sup>	–
Fillet of beef, approx. 1 kg <sup>1</sup>	 <sup>2</sup>	180–190 <sup>4</sup>	–	1	30–70	53–75
Fillet of beef, "rare", approx. 1 kg <sup>1</sup>	 <sup>2</sup>	95–100	–	1	65–75	53–55
Fillet of beef, "medium", approx. 1 kg <sup>1</sup>	 <sup>2</sup>	95–100	–	1	70–80	60–65
Fillet of beef, "well-done", approx. 1 kg <sup>1</sup>	 <sup>2</sup>	95–100	–	1	110–120	70–75
Sirloin joint, approx. 1 kg <sup>1</sup>	 <sup>2</sup>	180–200 <sup>4</sup>	✓	1	35–75	53–75
Sirloin joint, "rare", approx. 1 kg <sup>1</sup>	 <sup>2</sup>	95–100	–	1	40–50	53–55
Sirloin joint, "medium", approx. 1 kg <sup>1</sup>	 <sup>2</sup>	95–100	–	1	75–85	60–65
Sirloin joint, "well-done", approx. 1 kg <sup>1</sup>	 <sup>2</sup>	95–100	–	1	110–120	70–75
Burgers <sup>1</sup>	 <sup>3</sup>	3 <sup>5</sup>	–	2	1: 17–22 2: 5–10 <sup>7</sup>	–
Rissoles <sup>1</sup>	 <sup>3</sup>	3 <sup>5</sup>	–	2	1: 10–15 2: 5–10 <sup>7</sup>	–

 Function,  Temperature,  Booster,  Shelf level,  Cooking duration,  Core temperature,  Fan Plus,  Conventional Heat,  Special application Low temp. cooking,  Grill, ✓ On, – Off

<sup>1</sup> Use the rack and glass tray.

<sup>2</sup> Sear the meat on the cooktop first.

<sup>3</sup> Select the specified grill setting.

















<sup>4</sup> Pre-heat the oven before placing the food inside.











<sup>5</sup> Pre-heat the oven for 5 minutes before placing the food inside.

<sup>6</sup> Roast with the lid on first. Remove the lid after roasting for 60 minutes and add approx. 0.5 litre of liquid.

<sup>7</sup> Turn the food once it has browned sufficiently (1: Grill duration side 1, 2: Grill duration side 2).

## Veal

Food (accessories)		 +  [°C] + [W]		 <sup>3</sup>	 [min.]	 [°C]
Braised veal, approx. 1.5 kg (roasting dish with lid)	 <sup>2</sup>	160–170	✓	1	120–130 <sup>4</sup>	–
	 <sup>2</sup>	160–170 + 150	✓	1	80–90 <sup>4</sup>	–
Fillet of veal, approx. 1 kg (glass tray)	 <sup>2</sup>	180–190 <sup>3</sup>	–	1	20–50	53–75
Fillet of veal, “rare”, approx. 1 kg <sup>1</sup>	 <sup>2</sup>	95–100	–	1	50–60	53–55
Fillet of veal, “medium”, approx. 1 kg <sup>1</sup>	 <sup>2</sup>	95–100	–	1	80–90	60–65
Fillet of veal, “well-done”, approx. 1 kg <sup>1</sup>	 <sup>2</sup>	95–100	–	1	85–95	70–75
Saddle of veal, “rare”, approx. 1 kg <sup>1</sup>	 <sup>2</sup>	95–100	–	1	80–90	53–55
Saddle of veal, “medium”, approx. 1 kg <sup>1</sup>	 <sup>2</sup>	95–100	–	1	120–130	60–65
Saddle of veal, “well-done”, approx. 1 kg <sup>1</sup>	 <sup>2</sup>	95–100	–	1	140–150	70–75

 Function,  Temperature,  Booster, <sup>3</sup> Shelf level,  Cooking duration,  Core temperature,  Fan Plus,  Conventional Heat,  MW + Fan Plus,  Special application Low temp. cooking, ✓ On, – Off

<sup>1</sup> Use the rack and glass tray.

















<sup>2</sup> Sear the meat on the cooktop first.











<sup>3</sup> Pre-heat the oven before placing the food inside.

<sup>4</sup> Roast with the lid on first. Remove the lid after roasting for 60 minutes and add approx. 0.5 litre of liquid.

# Cooking charts















## Pork











Food (accessories)		 +  [°C] + [W]		 <sup>3</sup>	 [min.]	 [°C]
Pork joint/pork neck roast, approx. 1 kg (oven dish with lid)	 <sup>1</sup>	160–170 + 150	✓	1	80–90 <sup>5</sup>	80–90
		170–180	✓	1	100–110 <sup>5</sup>	80–90
Pork joint with crackling, approx. 2 kg (oven dish)	 <sup>1</sup>	170–180 + 150	✓	1	70–80 <sup>6</sup>	80–90
		170–180	✓	1	100–110 <sup>6</sup>	80–90
Fillet of pork, approx. 350 g (rack on the glass tray)	 <sup>2</sup>	95–100	–	1	60–120	60–75
Gammon joint, approx. 1 kg (glass tray)		170–180 + 150	–	1	40–50	75–80
Meat loaf, approx. 1 kg (glass tray)		170–180 + 150	–	1	35–45 <sup>6</sup>	80–85
		180–190	✓	1	60–70 <sup>6</sup>	80–85
Bacon (rack on the glass tray)	 <sup>3</sup>	3 <sup>4</sup>	–	2	5–10	–
Sausages (rack on the glass tray)	 <sup>3</sup>	3 <sup>4</sup>	–	2	15–20 <sup>7</sup>	–

 Function,  Temperature,  Booster, <sup>3</sup> Shelf level,  Cooking duration,  Core temperature,  MW + Auto Roast,  Conventional Heat,  Special application Low temp. cooking,  MW + Fan Plus,  Grill, ✓ On, – Off

- <sup>1</sup> Only use heat-resistant containers which are microwave safe.
- <sup>2</sup> Sear the meat on the cooktop first.
- <sup>3</sup> Select the specified grill setting.
- <sup>4</sup> Pre-heat the oven for 5 minutes before placing the food inside.
- <sup>5</sup> Roast with the lid on first. Remove the lid after roasting for 60 minutes and add approx. 0.5 litre of liquid.
- <sup>6</sup> Add approx. 0.5 l of liquid halfway through roasting.
- <sup>7</sup> Turn the food halfway through cooking.

## Lamb, game

Food (accessories)		 +  [°C] + [W]		 <sup>3</sup> <sub>1</sub>	 [min.]	 [°C]
Leg of lamb on the bone, approx. 1.5 kg (oven dish with lid)		170–180 + 80	✓	1	100–120 <sup>3</sup>	53–75
		180–190	✓	1	110–120 <sup>3</sup>	53–75
Saddle of lamb, off the bone (rack on the glass tray)	 <sup>1</sup>	180–190 <sup>2</sup>	–	1	15–40	53–75
	 <sup>1</sup>	95–100	–	1	35–90	53–75
Saddle of venison, off the bone (oven dish)	 <sup>1</sup>	180–190 <sup>2</sup>	–	1	45–75	54–57
Saddle of roebuck, off the bone (glass tray)	 <sup>1</sup>	140–150 <sup>2</sup>	–	1	20–40	60–81
Leg of wild boar, off the bone, approx. 1 kg (oven dish with lid)	 <sup>1</sup>	180–190	✓	1	90–120 <sup>3</sup>	80–90

 Function,  Temperature,  Booster, <sup>3</sup><sub>1</sub> Shelf level,  Cooking duration,  Core temperature,  MW + Auto Roast,  Conventional Heat,  Special application Low temp. cooking,  Auto Roast, ✓ On, – Off

- <sup>1</sup> Sear the meat on the cooktop first.
- <sup>2</sup> Pre-heat the oven before placing the food inside.
- <sup>3</sup> Roast with the lid on first. Remove the lid after roasting for 60 minutes and add approx. 0.5 litre of liquid.

# Cooking charts

## Poultry, fish

Food (accessories)		+ [°C] + [W]		<sup>3</sup> <sub>1</sub>	 [min.]	 [°C]
Poultry, 0.8–1.5 kg (rack on the glass tray)		160–170	✓ <sup>2</sup>	1	55–65	85–90
		170–180 + 150	–	1	40–50	85–90
Chicken, approx. 1.2 kg (rack on the glass tray)		180–190 <sup>1</sup>	– <sup>2</sup>	1	60–70 <sup>3</sup>	85–90
		200 + 150	–	1	45–55 <sup>3</sup>	85–90
Poultry, approx. 2 kg (shallow ovenproof dish on the glass tray)		160–170	✓ <sup>2</sup>	1	110–140	85–90
		170–180 + 80	–	1	100–120	85–90
Poultry, approx. 4 kg (oven dish on the glass tray)		160–170 + 80	–	1	150–160 <sup>4</sup>	90–95
		180–190	✓ <sup>2</sup>	1	180–200 <sup>4</sup>	90–95
Fish, 200–300 g (e.g. trout) (glass tray)		160–170 + 150	–	1	15–25	75–80
Fish, 1–1.5 kg (e.g. Australian salmon) (glass tray)		160–170 + 150	–	1	20–30	75–80

Function, Temperature, Booster, <sup>3</sup><sub>1</sub> Shelf level, Cooking duration, Core temperature, Auto Roast, MW + Auto Roast, Fan Grill, MW + Fan Grill, MW + Fan Plus, Conventional Heat, ✓ On, – Off

- <sup>1</sup> Pre-heat the oven for 5 minutes before placing the food inside.
- <sup>2</sup> Switch on the Crisp function.
- <sup>3</sup> Turn the food halfway through grilling.
- <sup>4</sup> Add approx. 0.5 litre of liquid after 30 minutes.

### **Copyright and licences for the communication module**

For the purpose of operating and controlling the communication module, Miele uses proprietary or third-party software that is not covered by open source licensing terms. These items of software/software components are protected by copyright. The copyright powers of Miele and third parties must be respected.

In addition, the communication module contains software components which are distributed under open source licensing terms. The open source components contained in the appliance along with the corresponding copyright notices, copies of the licensing terms valid at the time, and any further information can be accessed locally via IP using a web browser (*http://<IP address>/Licenses*), where <IP address> is the IP address of the appliance. The liability and warranty arrangements for the open source licences displayed in this location only apply in relation to the respective rights holders.

# Technical data

---

## Copyright and licences

For the purpose of operating and controlling the appliance, Miele uses proprietary or third-party software that is not covered by open source licensing terms. These items of software/software components are protected by copyright. The copyright powers of Miele and third parties must be respected.

In addition, the appliance contains software components which are distributed under open source licensing terms. You can access these open source components along with the associated copyright notices, copies of the valid licensing terms and any further information in the appliance under [Settings](#) | [Legal information](#) | [Open source licences](#). The liability and warranty arrangements for the open source licences displayed at this location only apply in relation to the respective rights holders.

The appliance contains, in particular, software components which are licensed by the rights holders under the GNU General Public License, version 2, or the GNU Lesser General Public License, version 2.1. For a period of at least 3 years following the purchase or delivery of the appliance, Miele shall provide you or third parties with a machine-readable copy of the source code for the open source components contained in the appliance, which are licensed under the terms of the GNU General Public License, version 2, or the GNU Lesser General Public License, version 2.1. The source code shall be made available on a data carrier (CD-ROM, DVD or USB stick). To obtain this source code, please contact us, specifying the product name, serial number and purchase date, by sending us an e-mail ([info@miele.com](mailto:info@miele.com)) or writing to the following address:

Miele & Cie. KG  
Open Source  
GTZ/TIM  
Carl-Miele-Straße 29  
33332 Gütersloh, Germany

We wish to draw your attention to the limited warranty for the benefit of rights owners under the terms of the GNU General Public License, version 2, and the GNU Lesser General Public License, version 2.1:

*This program is distributed in the hope that it will be useful, but WITHOUT ANY WARRANTY, without even the implied warranty of MERCHANTABILITY of FITNESS FOR A PARTICULAR PURPOSE. See the GNU General Public License and GNU Lesser General Public License for more details.*

**Miele Australia Pty. Ltd.**

ACN 005 635 398

ABN 96 005 635 398

Level 4, 141 Camberwell Road  
Hawthorn East, VIC 3123

**1300 464 353 (1300 4 MIELE)**

**info@miele.com.au**

**www.miele.com.au**

**Miele New Zealand Limited**

IRD 98 463 631

8 College Hill  
Freemans Bay, Auckland 1011

**0800 464 353 (0800 4 MIELE)**

**customercare@miele.co.nz**

**www.miele.co.nz**

**Miele Global Headquarters**

**Germany**

**Miele & Cie. KG**

Carl-Miele-Straße 29

33332 Gütersloh

Federal Republic of Germany

H 7840 BMX

en-AU, NZ

M.-Nr. 11 196 870 / 17