



**Microwave Oven**  
**INSTRUCTION MANUAL**  
**MODEL: SAM34CXI**

**Read these instructions carefully before using your microwave oven, and keep it carefully.**

If you follow the instructions, your oven will provide you with many years of good service.

**SAVE THESE INSTRUCTIONS CAREFULLY**



# PRECAUTIONS TO AVOID POSSIBLE EXPOSURE TO EXCESSIVE MICROWAVE ENERGY

(a) Do not attempt to operate this oven with the door open since this can result in harmful exposure to microwave energy. It is important not to break or tamper with the safety interlocks.

(b) Do not place any object between the oven front face and the door or allow soil or cleaner residue to accumulate on sealing surfaces.

(c) WARNING: If the door or door seals are damaged, the oven must not be operated until it has been repaired by a competent person.

## ADDENDUM

If the apparatus is not maintained in a good state of cleanliness, its surface could be degraded and affect the lifespan of the apparatus and lead to a dangerous situation.

## Specifications

Model:	SAM34CXI
Rated Voltage:	240V~50Hz
Rated Input Power(Microwave):	1750W
Rated Output Power(Microwave):	1100W
Rated Input Power(Grill):	1100W
Rated Input Power(Convection):	2100W
Oven Capacity:	34L
Turntable Diameter:	∅ 315mm
External Dimensions:	519×507×315mm
Net Weight:	Approx. 15.5 kg

# **IMPORTANT SAFETY INSTRUCTIONS**

## **WARNING**

To reduce the risk of fire, electric shock, injury to persons or exposure to excessive microwave oven energy when using your appliance, follow basic precautions, including the following:

1. Warning: Liquids and other foods must not be heated in sealed containers since they are liable to explode.
2. Warning: It is hazardous for anyone other than a competent person to carry out any service or repair operation that involves the removal of a cover which gives protection against exposure to microwave energy.
3. This appliance can be used by children aged from 8 years and above and persons with reduced physical, sensory or mental capabilities or lack of experience and knowledge if they have been given supervision or instruction concerning use of the appliance in a safe way and understand the hazards involved. Children shall not play with the appliance. Cleaning and user maintenance shall not be made by children unless they are older than 8 and supervised.
4. Keep the appliance and its cord out of reach of children less than 8 years.
5. Only use utensils suitable for use in microwave ovens.
6. The oven should be cleaned regularly and any food deposits should be removed.
7. Read and follow the specific: "PRECAUTIONS TO AVOID POSSIBLE EXPOSURE TO EXCESSIVE MICROWAVE ENERGY".
8. When heating food in plastic or paper containers, keep an eye on the oven due to the possibility of ignition.

9. If smoke is emitted, switch off or unplug the appliance and keep the door closed in order to stifle any flames.
10. Do not overcook food.
11. Do not use the oven cavity for storage purposes. Do not store items, such as bread, cookies, etc. inside the oven.
12. Remove wire twist-ties and metal handles from paper or plastic containers/bags before placing them in the oven.
13. Install or locate this oven only in accordance with the installation instructions provided.
14. Eggs in the shell and whole hard-boiled eggs should not be heated in microwave ovens since they may explode, even after microwave heating has ended.
15. This appliance is intended to be used in household and similar applications such as:
  - staff kitchen areas in shops, offices and other working environments;
  - by clients in hotels, motels and other residential type environments;
  - farm houses;
  - bed and breakfast type environments.
16. If the supply cord is damaged, it must be replaced by the manufacturer, its service agent or similarly qualified persons in order to avoid a hazard.
17. Do not store or use this appliance outdoors.
18. Do not use this oven near water, in a wet basement or near a swimming pool.
19. The temperature of accessible surfaces may be high when the appliance is operating. The surfaces are liable to get hot during use. Keep cord away from heated surface, and do not cover any vents on the oven.

20. Do not let cord hang over edge of table or counter.
21. Failure to maintain the oven in a clean condition could lead to deterioration of the surface that could adversely affect the life of the appliance and possibly result in a hazardous situation.
22. The contents of feeding bottles and baby food jars shall be stirred or shaken and the temperature checked before consumption, in order to avoid burns.
23. Microwave heating of beverages can result in delayed eruptive boiling, therefore care must be taken when handling the container.
24. The appliance is not intended for use by persons (including children) with reduced physical, sensory or mental capabilities, or lack of experience and knowledge, unless they have been given supervision or instruction concerning use of the appliance by a person responsible for their safety.
25. Children should be supervised to ensure that they do not play with the appliance.
26. The appliances are not intended to be operated by means of an external timer or separate remote-control system.
27. Accessible parts may become hot during use. Young children should be kept away.
28. Steam cleaner is not to be used.
29. During use the appliance becomes hot. Care should be taken to avoid touching heating elements inside the oven.
30. Only use the temperature probe recommended for this oven. (for ovens provided with a facility to use a temperature-sensing probe.)

- 31.WARNING: The appliance and its accessible parts become hot during use.Care should be taken to avoid touching heating elements. Children less than 8 years of age shall be kept away unless continuously supervised.
- 32.The microwave oven must be operated with the decorative door open.(for ovens with a decorative door.)
- 33.Surface of a storage cabinet can get hot.

**READ CAREFULLY AND KEEP FOR FUTURE REFERENCE**

# To Reduce the Risk of Injury to Persons Grounding Installation

## **DANGER**

Electric Shock Hazard  
Touching some of the internal components can cause serious personal injury or death. Do not disassemble this appliance.

## **WARNING**

Electric Shock Hazard  
Improper use of the grounding can result in electric shock. Do not plug into an outlet until appliance is properly installed and grounded.

This appliance must be grounded. In the event of an electrical short circuit, grounding reduces the risk of electric shock by providing an escape wire for the electric current. This appliance is equipped with a cord having a grounding wire with a grounding plug. The plug must be plugged into an outlet that is properly installed and grounded.

Consult a qualified electrician or serviceman if the grounding instructions are not completely understood or if doubt exists as to whether the appliance is properly grounded. If it is necessary to use an extension cord, use only a 3-wire

1. A short power-supply cord is provided to reduce the risks resulting from becoming entangled in or tripping over a longer cord.
2. If a long cord set or extension cord is used:
  - 1) The marked electrical rating of the cord set or extension cord should be at least as great as the electrical rating of the appliance.
  - 2) The extension cord must be a grounding-type 3-wire cord.
  - 3) The long cord should be arranged so that it will not drape over the counter top or tabletop where it can be pulled on by children or tripped over unintentionally.

## CLEANING

Be sure to unplug the appliance from the power supply.

1. Clean the cavity of the oven after using with a slightly damp cloth.
2. Clean the accessories in the usual way in soapy water.
3. The door frame and seal and neighbouring parts must be cleaned carefully with a damp cloth when they are dirty.
4. Do not use harsh abrasive cleaners or sharp metal scrapers to clean the oven door glass since they can scratch the surface, which may result in shattering of the glass.
5. Cleaning Tip---For easier cleaning of the cavity walls that the food cooked can touch: Place half a lemon in a bowl, add 300ml (1/2 pint) water and heat on 100% microwave power for 10 minutes. Wipe the oven clean using a soft, dry cloth.

## UTENSILS

### CAUTION

#### **Personal Injury Hazard**

It is hazardous for anyone other than a competent person to carry out any service or repair operation that involves the removal of a cover which gives protection against exposure to microwave energy.

See the instructions on "Materials you can use in microwave oven or to be avoided in microwave oven."

There may be certain non-metallic utensils that are not safe to use for microwaving. If in doubt, you can test the utensil in question following the procedure below.

Utensil Test:

1. Fill a microwave-safe container with 1 cup of cold water (250ml) along with the utensil in question.
2. Cook on maximum power for 1 minute.
3. Carefully feel the utensil. If the empty utensil is warm, do not use it for microwave cooking.
4. Do not exceed 1 minute cooking time.

## Materials you can use in microwave oven

Utensils	Remarks
Aluminum foil	Shielding only. Small smooth pieces can be used to cover thin parts of meat or poultry to prevent overcooking. Arcing can occur if foil is too close to oven walls. The foil should be at least 1 inch (2.5cm) away from oven walls.
Browning dish	Follow manufacturer's instructions. The bottom of browning dish must be at least 3/16 inch (5mm) above the turntable. Incorrect usage may cause the turntable to break.
Dinnerware	Microwave-safe only. Follow manufacturer's instructions. Do not use cracked or chipped dishes.
Glass jars	Always remove lid. Use only to heat food until just warm. Most glass jars are not heat resistant and may break.
Glassware	Heat-resistant oven glassware only. Make sure there is no metallic trim. Do not use cracked or chipped dishes.
Oven cooking bags	Follow manufacturer's instructions. Do not close with metal tie. Make slits to allow steam to escape.
Paper plates and cups	Use for short-term cooking/warming only. Do not leave oven unattended while cooking.
Paper towels	Use to cover food for reheating and absorbing fat. Use with supervision for a short-term cooking only.
Parchment paper	Use as a cover to prevent splattering or a wrap for steaming.
Plastic	Microwave-safe only. Follow the manufacturer's instructions. Should be labeled "Microwave Safe". Some plastic containers soften, as the food inside gets hot. "Boiling bags" and tightly closed plastic bags should be slit, pierced or vented as directed by package.
Plastic wrap	Microwave-safe only. Use to cover food during cooking to retain moisture. Do not allow plastic wrap to touch food.
Thermometers	Microwave-safe only (meat and candy thermometers).
Wax paper	Use as a cover to prevent splattering and retain moisture.

## Materials to be avoided in microwave oven

Utensils	Remarks
Aluminum tray	May cause arcing. Transfer food into microwave-safe dish.
Food carton with metal handle	May cause arcing. Transfer food into microwave-safe dish.
Metal or metal-trimmed utensils	Metal shields the food from microwave energy. Metal trim may cause arcing.
Metal twist ties	May cause arcing and could cause a fire in the oven.
Paper bags	May cause a fire in the oven.
Plastic foam	Plastic foam may melt or contaminate the liquid inside when exposed to high temperature.
Wood	Wood will dry out when used in the microwave oven and may split or crack.

# SETTING UP YOUR OVEN

## Names of Oven Parts and Accessories

Remove the oven and all materials from the carton and oven cavity.

Your oven comes with the following accessories:

Glass tray	1
Turntable ring assembly	1
Instruction Manual	1

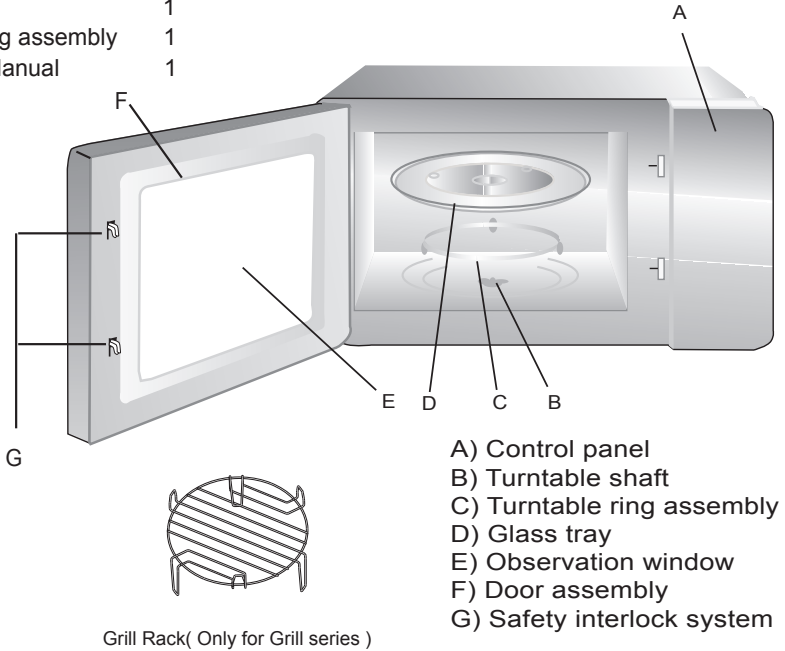

## Turntable Installation

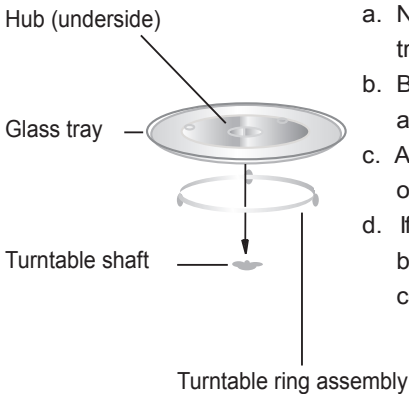

- Never place the glass tray upside down. The glass tray should never be restricted.
- Both glass tray and turntable ring assembly must always be used during cooking.
- All food and containers of food are always placed on the glass tray for cooking.
- If glass tray or turntable ring assembly cracks or breaks, contact your nearest authorized service center.

## Installation and connection

- 1.This appliance is only intended for domestic use.
- 2.This oven is intended for built-in use only.It is not intended for counter-top use or for use inside a cupboard.
3. Please observe the special installation instructions.
- 4.The appliance can be installed in a 60cm wide wall-mounted cupboard(at lease 55cm deep and 85cm off the floor).
- 5.The appliance is fitted with a plug and must only be connected to a properly installed earthed socket.
- 6.The mains voltage must correspond to the voltage specified on the rating plate.
- 7.The socket must be installed and connecting cable must only be replaced by a qualified electrician.If the plug is no longer to accessible following installation,an all-pole disconnecting device must be present on the installation side with a contact gap of at lease 3mm.
- 8.Adapters,multi-way strips and extension leads must not be used. Overloading can result in a risk of fire.

**The accessible surfacemay  
be hot during operation.**



# OPERATION INSTRUCTION

This microwave oven uses modern electronic control to adjust cooking parameters to meet your needs better for cooking.

## 1. Clock Setting

When the microwave oven is electrified, the oven will display "00:00", "" will display.

1) Turn "" to adjust the hour figures, the input time should be within 0--23(24-hour).

---

2) Press "**Start/+30Sec./Confirm**" , the minute figures will flash.

---

3) Turn "" to adjust the minute figures, the input time should be within 0--59.

---

4) Press "**Start/+30Sec./Confirm**" to finish clock setting. ":" will flash.

Note: 1) If the clock is not set, it would not function when powered.

2) During the process of clock setting, if you press "**Stop/Clear**" , the oven will go back to the previous status automatically.

## 2. Microwave Cooking

1) Press the "**Microwave**" key once, and "110" display.

---

2) Press the "**Microwave**" again to select the microwave power. "330", "550", "880", "1100" will display in order.

---

3) Press "**Start/+30Sec./Confirm**" to confirm.

---

4) Turn "" to adjust the cooking time. (The time setting should be 0:05- 95:00.)

---

5) Press "**Start/+30Sec./Confirm**" to start cooking.

NOTE: the step quantities for the adjustment time of the coding switch are as follow:

0---1 min	:	5 seconds
1---5 min	:	10 seconds
5---10 min	:	30 seconds
10---30 min	:	1 minute
30---95 min	:	5 minutes

5 power levels are available.

Level	5	4	3	2	1
Power	100%	80%	50%	30%	10%
Display	1100	880	550	330	110

### 3. Grill Cooking

1) Press the " **Grill/Combi.** " key once, and "G-1" display.

---

2) Press " **Start/+30Sec./Confirm** " to confirm.

---

3) Turn "  " to adjust the cooking time. (The time setting should be 0:05- 95:00.)

---

4) Press " **Start/+30Sec./Confirm** " to start cooking.

Note: If half the grill time passes, the oven pause and sound twice to tell you to turn the food over. In order to have a better effect of grilling food, you should turn the food over, close the door, and then press " **Start/+30Sec./Confirm** " to continue cooking. If no operation, the oven will wait one minute and work automatically.

### 4. Combination Cooking (Microwave+Convection)

1) Press the " **Grill/Combi.** " key once, and "G-1" display.

---

2) Press the " **Grill/Combi.** " key again to select the combination way.

Stop pressing when "C-1", "C-2", "C-3" and "C-4" displays.

---

3) Press " **Start/+30Sec./Confirm** " to confirm.

---

4) Turn "  " to adjust the cooking time. (The time setting should be 0:05- 95:00.)

---

5) Press " **Start/+30Sec./Confirm** " to start cooking.

### 5. Convection Cooking (With preheating function)

The convection cooking can let you to cook the food as a traditional oven. Microwave is not used. It is recommended that you should preheat the oven to the appropriate temperature before placing the food in the oven.

1) Press the " **Convection** " key once, "150" °C flash.

2) Press the " **Convection** " key again to select the convection function.

Note: the temperature can be chosen from 150 degrees to 200 degrees.

---

3) Press the " **Start/+30Sec./Confirm** " to confirm the temperature.

---

4) Press the " **Start/+30Sec./Confirm** " to start preheating. When the preheating temperature arrives, the buzzer will sound twice to remind you to put the food into the oven. And the preheated temperature is displayed and flash.

---

5) Put the food into the oven and close the door.

Turn "  " to adjust the cooking time. (The maximum setting time is 95 minutes.)

6) Press the " **Start/+30Sec./Confirm** " key to start cooking.

Note: a. Cooking time cannot be input until the preheating temperature arrives.

If the temperature arrives, door must be opened to input the cooking time.

b. If the time not input in 5 minutes, the oven will stop preheating. The buzzer sound five times and turn back to waiting states.

## 6. Convection Cooking( Without pre-heating function)

1) Press the " **Convection** " key once, "150"°C flash.

2) Press the " **Convection** "key again to select the convection function.

Note:the temperature can be chosen from 150 degrees to 200 degrees.

---

3) Turn "  " to adjust the cooking time. (The maximum setting time is 95 minutes.)

---

4) Press the " **Start/+30Sec./Confirm** " key to start cooking.

## 7.Multi-Stage Cooking

Two stages can be maximumly set. If one stages is defrosting, it should be put in the first stage. The buzzer will ring once after each stage and the next stage will begin.

Note: Auto menu and preheating cannot be set as one of the multi-stage.

Example: if you want to defrost the food of 500g, then to cook with 80% microwave power for 7 minutes. The steps are as following:

1) Press " **Defrost** " once, the screen will display "100"**g**;

2) Turn "  " to adjust the defrost weight of 500g;

3) Press" **Microwave** " once;

4) Turn "  " to choose 80% microwave power till "P80" display;

5) Press " **Start/+30Sec./Confirm** " to confirm;

6) Turn "  " to adjust the cooking time of 7 minutes;

7) Press " **Start/+30Sec./Confirm** " to start cooking.

## 8. Speedy Cooking

In waiting state, press " **Start/+30Sec./Confirm** " key to cook with 100% power level for 30 seconds. Each press on the same key can increase 30 seconds. The maximum cooking time is 95 minutes.

Note: This function cannot work under defrost and auto menu cooking.

## 9. Defrost by Weight

1) Press " **Defrost** " pad once, the oven will display "100"**g**.

---

2) Turn "  " to select the weight of food. At the same time, "g" will light. The weight should be 100-2000g.

---

3) Press " **Start/+30Sec./Confirm** " key to start defrosting.

## 10. Defrost by Time

1) Press " **Defrost** " key twice, the oven will display "0:00"

2) Turn "  " to select the cooking time. The maximum setting time is 95 minutes.

3) Press " **Start/+30Sec./Confirm** " key to start defrosting.

## 11. Auto Menu

1) Press " **Auto menu** ", "S-01" displays, "  " will flash.

2) Press " **Auto menu** " repeatedly, you could choose different function.

3) Turn "  " right to choose the function wanted, and "S-01", "S-02", "S-03".... will be displayed.

4) Press " **Start/+30Sec./Confirm** " to confirm the menu you need.

5) Turn "  " to choose the weight of menu, and "g" indicator will light.

6) Press " **Start/+30Sec./Confirm** " to start cooking.

## 12. Inquiring Function

In cooking state, press " **Microwave** "; " **Grill/Combi.** " or " **Convection** " the current power will be displayed for 2-3 seconds.

## 13. Lock-out Function for Children

Lock: In waiting state, press " **Stop/Clear** " for 3 seconds, there will be a long "beep" denoting entering into the children-lock state and "  " indicator will light. LED will display current time or 0:00.

Lock quitting: In locked state, press " **Stop/Clear** " for 3 seconds, there will be a long "beep" denoting that the lock is released, and "  " indicator will disappear.

#### 14. Specification

- (1) The buzzer will sound once when turning the knob at the beginning;
- (2) " **Start/+30Sec./Confirm** " must be pressed to continue cooking if the door is opened during cooking;
- (3) Once the cooking programme has been set , " **Start/+30Sec./Confirm** " is not pressed in 5 minutes. The current time will be displayed. The setting will be cancelled.
- (4) The buzzer sounds once by efficient press, inefficient press will be no response.
- (5) The buzzer will sound three times to remind you when cooking is finished.

# Auto menu Chart

Category	Menu	Weight	Display	Power
soft	Butter (S-01)	50g	50g	P2
		100g	100g	
		150g	150g	
	Ice cream (S-02)	250g	250g	P5
		500g	500g	
MELT	Butter (S-01)	50g	50g	P5
		100g	100g	
		150g	150g	
	Chocolate (S-02)	50g	50g	P8
		100g	100g	
		150g	150g	
	Cheese (S-03)	50g	50g	P5
		100g	100g	
		150g	150g	
defrost	Meat (S-01)	/	/	/
	Poultry (S-02)	/	/	
	Fish (S-03)	/	/	
speed grill	Pork (S-01)	600g	600g	P5+G
		800g	800g	
		1000g	1000g	
	beef (S-02)	600g	600g	P4+G
		800g	800g	
		1000g	1000g	
	Chicken (S-03)	800g	800g	P4+G
		1000g	1000g	
		1200g	1200g	
stew	Chicken (S-01)	/	/	P10/P5
	Curry (S-02)	/	/	
keep warm	keep warm (S-01)	/	/	P1
cake	cake (S-01)	475g	475g	Preheat 160 degrees

vegetable	vegetable (S-01)	200g	200g	P10
		300g	300g	
		400g	400g	
pizza	pizza (S-01)	200g	200g	200 degrees
		400g	400g	
Others More	Beverage (S-01)	1 cup	1	P10
		2 cups	2	
		3 cups	3	
	potato (S-02)	200g	200g	P10
		400g	400g	
		600g	600g	
	meat (S-03)	250g	250g	P10
		350g	350g	
		450g	450g	
	fish (S-04)	250g	250g	P8
		350g	350g	
		450g	450g	
	pasta (S-05)	50g	50g	P8
		100g	100g	
		150g	150g	
	popcorn (S-06)	50g	50g	P10
		100g	100g	

## Trouble shooting

<b>Normal</b>	
Microwave oven interfering TV reception	Radio and TV reception may be interfered when microwave oven operating. It is similar to the interference of small electrical appliances, like mixer, vacuum cleaner, and electric fan. It is normal.
Dim oven light	In low power microwave cooking, oven light may become dim. It is normal.
Steam accumulating on door, hot air out of vents	In cooking, steam may come out of food. Most will get out from vents. But some may accumulate on cool place like oven door. It is normal.
Oven started accidentally with no food in.	It is forbidden to run the unit without any food inside. It is very dangerous.

<b>Trouble</b>	<b>Possible Cause</b>	<b>Remedy</b>
Oven can not be started.	(1) Power cord not plugged in tightly.	Unplug. Then plug again after 10 seconds.
	(2) Fuse blowing or circuit breaker works.	Replace fuse or reset circuit breaker (repaired by professional personnel of our company)
	(3) Trouble with outlet.	Test outlet with other electrical appliances.
Oven does not heat.	(4) Door not closed well.	Close door well.
Glass turntable makes noise when microwave oven operates	(5) Dirty roller rest and oven bottom.	Refer to "Maintenance of Microwave" to clean dirty parts.



According to Waste of Electrical and Electronic Equipment (WEEE) directive, WEEE should be separately collected and treated. If at any time in future you need to dispose of this product please do NOT dispose of this product with household waste. Please send this product to WEEE collecting points where available.